

Worldwide offices

International **TADANO LTD.**
International Division
4-12, Kamezawa 2-chome
Sumida-Ku, Tokyo 130-0014, Japan
Phone: +81-3-3621-7750
Fax: +81-3-3621-7785
E-mail: tdnihq@tadano.co.jp

TADANO AMERICA CORPORATION
333 Northpark Central Drive, Suite Z
Houston, Texas 77073, USA
Phone: +1-281-869-0030
Fax: +1-281-869-0040
E-mail: sales@tadano-cranes.com

TADANO LTD. Middle East Representative Office
P.O.Box 18302, LOB15-323
Jebel Ali Free Zone, Dubai, UAE
Phone: +971-4-887-1353
Fax: +971-4-887-1703
E-mail: tadano@tadano.ae

TADANO LTD. Beijing Office
Jing Guang Centre, Room 2905, Hu Jia Lou
Chao Yang Qu,
Beijing, China
Phone: +86-10-6597-3210
Fax: +86-10-6597-3220
E-mail: beijing@tadano.co.jp

Europe **TADANO FAUN GmbH**
Faunberg 2
91207 Lauf a. d. Pegnitz
Germany
Phone: +49-9123-955-0
Fax: +49-9123-3085
E-mail: info@tadanofaun.de

TADANO SOUTH CHINA CO. LTD.
Room 1803, 18/F Seaview Commercial
Building 21-24 Connaught Road West
Hong Kong, China
Phone: +852-2544-9310
Fax: +852-2541-5828
E-mail: hiwa@tadanosc.com

TADANO Korea Co Ltd.
302, Koram Venture Town B/D, 907-1,
Daechi-Dong, Gangnam-Ku,
Seoul, Korea
Phone: +82-2-714-1600
Fax: +82-2-3274-1304
E-mail: tadano@korea.com

TADANO Asia Pte Ltd.
11 Tuas View Crescent
Multico Building
Singapore 637643
Phone: +65-6863-6901
Fax: +65-6863-6902
E-mail: Tdn-crane@tadanoasia.com

TAIWAN TADANO LTD.
4F, No.50, Sung Chiang Road
Taipei,
Taiwan
Phone: +886-2-2523-1388
Fax: +886-2-2523-3988

TADANO FAUN HOLLAND B.V.
Antennestraat 6
3903 LZ Veenendaal
The Netherlands
Phone: +31-318-546-700
Fax: +31-318-542-282
E-mail: info@tadano-faun.nl

Detaillierte Informationen über unsere Internationalen Händler und Service Niederlassungen finden Sie im Internet.
For detailed information about our International Distributor and Service network, please refer to our homepages.

www.tadano.co.jp + www.tadanofaun.de + www.tadanoamerica.com

Herausgeber / Publisher:

TADANO FAUN GmbH
P.O.Box 10 02 64
91205 Lauf
Germany



ALL-TERRAIN ATF 220G-5

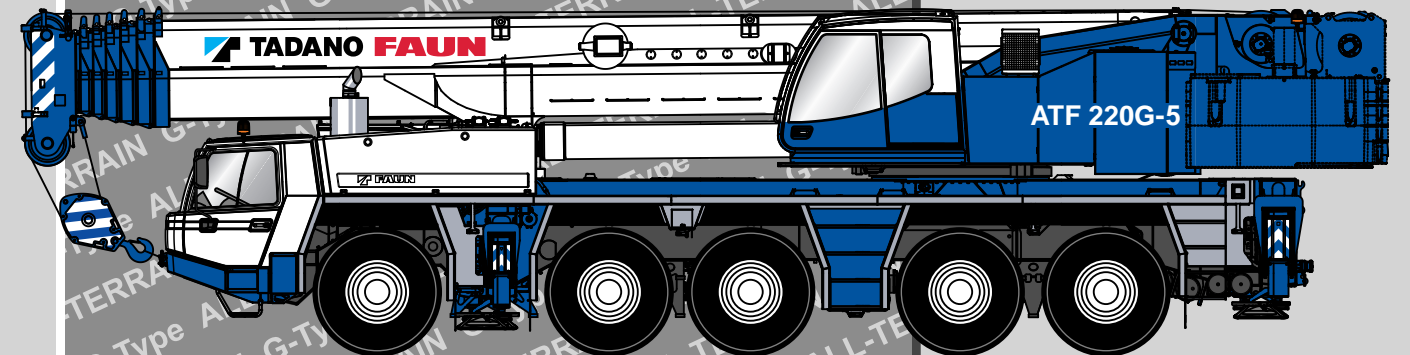

Maße (mm)
 Dimensions (mm)
 Dimensiones (mm)

14.00 R 25
 (385/95 R 25)

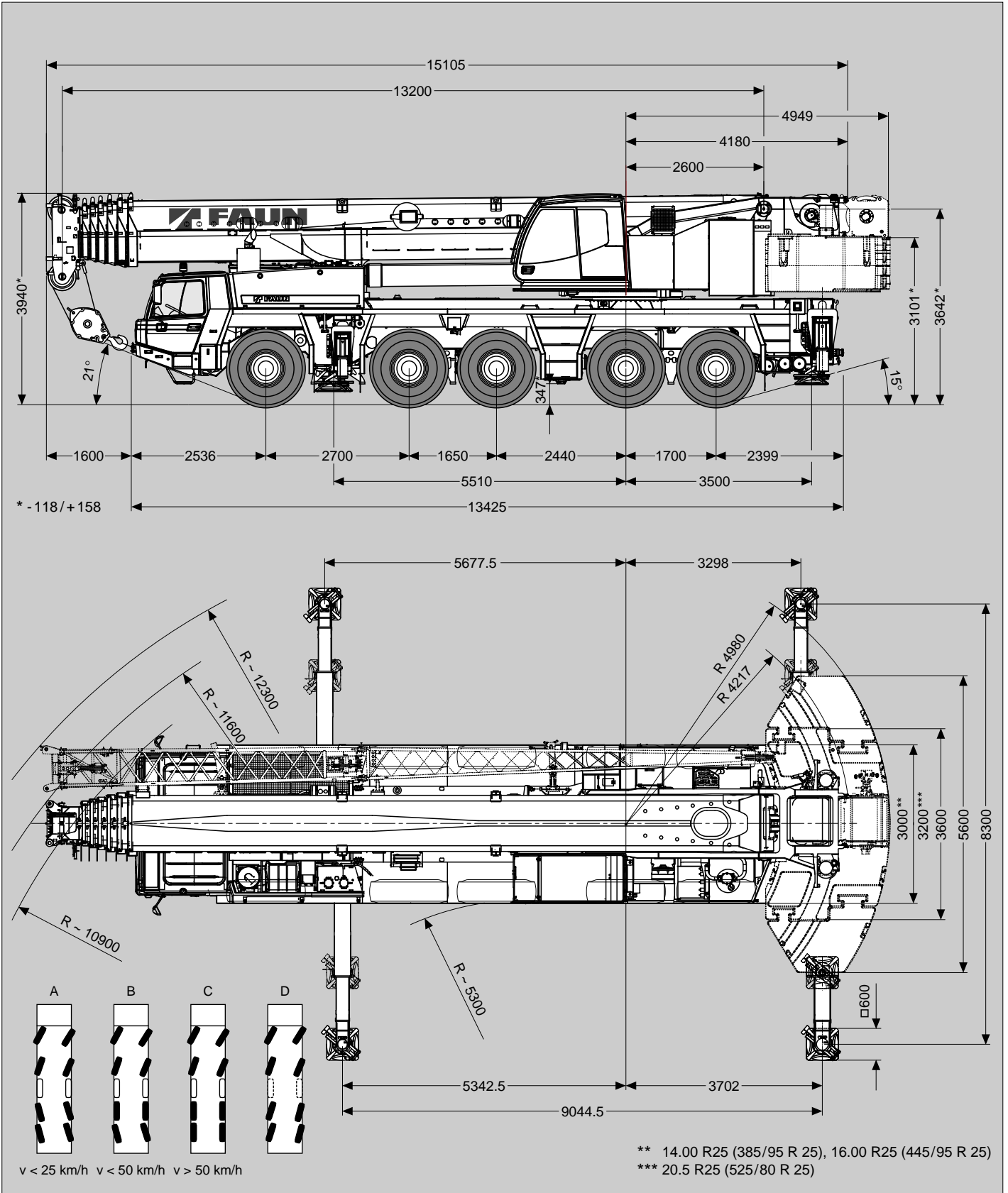



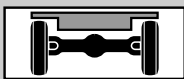

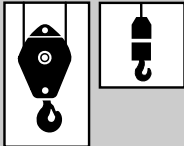

Gewichte / Geschwindigkeiten
Weights / Working speeds
Poids / Vitesses
Pesos / Velocidades de trabajo

	Achse / Axle Essieu / Eje	1	2	3	4	5	Gesamtgewicht / Total weight Poids total / Peso total
	(t)	12	12	12	12	12	60







 * Doppelhaken * Rams horn * Moufle avec crochet marin * Gancho doble	Traglast / Lifting capacity / Force de levage / Capacidad de elevación	Rollen / Sheaves Pulies / Poleas	Stränge / Parts of line Brins / Ramales de cable	Gewicht / Weight Poid / Peso
	160 t*	9	19	1600 kg
	125 t*	7	15	1350 kg
	80 t*	5	11	1150 kg
	63 t*	3	7	850 kg
	63 t	3	7	850 kg
	25 t	1	3	450 kg
10 t	–	1	300 kg	



		1	2	3	4	5	6	7	8	9	10	11	12	13	14	15	16	R1	R2	
		14.00 (385/95) km/h		2	3	3	4	5	6	7	8	10	13	15	19	22	27	32	39	
16.00 (445/95) km/h		3	3	4	4	5	7	8	9	11	14	17	20	24	30	35	42	3	3	> 61%*
		6	7	8	10	12	15	18	21	26	31	38	46	56	68	80	85	6	7	47%

* Mit Geländeübersetzung
* Off road range

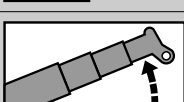
* Avec mode tout terrain
* Con transmisión todo terreno

V+ 	Stufenlos Infinitely variable Progressivement variable Infinítamente variable	Seil Rope Câble Cable	Max. Seilzug Max. single line pull Effort maxi au brin simple Trio máximo por ramal
	0 - 128 m/min für einfachen Strang single line au brin simple ramal simple	21 mm / 320 m	98 kN
	0 - 128 m/min für einfachen Strang single line au brin simple ramal simple	21 mm / 320 m	98 kN
	0 - 1.2 min ⁻¹		
	-1.5° – +84° ca. 50 s approx. 50 s env. 50 s aproximadamente 50 s		
	13.2 m – 68.0 m ca. 500 s approx. 500 s env. 500 s aproximadamente 500 s		

Tragfähigkeiten
Lifting capacities
Capacités de levage
Capacidades de elevación

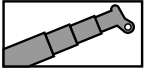

DIN/ISO/EN

→ m	13.2 m*	13.2 m	17.4 m	21.6 m	25.8 m	30.0 m	34.1 m	38.3 m	42.5 m	46.7 m	50.9 m	55.0 m	59.2 m	63.4 m	68.0 m
2.5	220.0**														
3.0	180.0**														
3.5	169.5**	176.5**	140.0**	140.0**	114.0**										
4.0	160.0**	160.0**	140.0**	140.0**	114.0**	90.5									
4.5	150.5**	138.0**	137.5**	136.5**	103.5	90.5	70.0								
5.0	135.5**	127.0**	126.5**	126.0**	103.0	87.0	70.0	54.5							
6.0	112.5	109.0	109.0	108.0	103.0	79.8	70.0	54.5	43.5						
7.0	96.3	95.5	95.1	94.2	94.9	77.5	66.2	54.5	43.5	34.5					
8.0	83.6	83.6	83.2	82.4	83.0	77.5	61.2	54.5	43.5	34.5	28.5				
9.0	73.5	73.5	73.1	72.2	72.8	73.6	58.0	52.0	43.4	34.5	28.5	23.0			
10.0	65.4	65.4	64.9	64.0	64.6	65.4	58.0	48.9	41.4	34.5	28.5	23.0	18.8		
11.0			58.2	57.4	57.9	58.6	56.7	45.7	39.4	34.1	28.5	23.0	18.8	15.0	
12.0			52.6	51.8	52.3	53.0	54.0	42.8	37.6	32.6	28.3	23.0	18.8	15.0	13.8
14.0			43.9	43.1	43.6	44.3	45.1	40.0	35.6	30.0	26.8	22.8	18.8	15.0	13.8
16.0				36.6	37.0	37.7	38.5	37.3	32.4	28.5	24.9	21.8	18.8	15.0	13.8
18.0				31.6	31.9	32.6	33.4	34.1	29.3	26.4	23.1	20.4	18.3	15.0	13.4
20.0					27.5	28.3	30.4	30.0	26.8	24.5	21.5	19.1	17.2	15.0	13.1
22.0					23.7	26.2	27.0	26.2	24.6	22.9	20.1	17.8	16.2	14.8	12.8
24.0						24.1	23.7	22.9	22.1	21.2	18.8	16.7	15.2	14.0	12.5
26.0						21.5	21.0	20.2	19.4	19.2	17.6	15.7	14.4	13.3	12.2
28.0							18.7	17.9	17.2	17.0	16.6	14.8	13.6	12.6	11.4
30.0							16.8	16.0	16.2	15.1	15.2	14.0	12.8	11.9	10.6
32.0								14.4	15.0	13.4	13.6	13.2	12.1	11.3	9.9
34.0								13.0	13.6	12.0	12.5	12.5	11.5	10.8	9.3
36.0									12.4	11.5	12.0	11.2	10.9	10.2	8.7
38.0									11.3	11.0	10.9	10.1	10.4	9.8	8.2
40.0										10.6	9.9	9.3	9.4	9.3	7.7
42.0										9.8	9.0	8.7	8.6	8.5	7.3
44.0										8.1	8.3	8.2	7.9	8.0	6.8
46.0											7.6	7.6	7.5	7.5	6.4
48.0											7.0	7.0	7.1	6.8	6.1
50.0												6.4	6.7	6.2	5.7
52.0												5.9	6.2	5.7	5.4
54.0													5.7	5.2	5.1
56.0													5.3	4.7	4.7
58.0														4.3	4.2
60.0														3.9	3.9
62.0															3.5
64.0															3.2

* Nach hinten / * Over rear / * A l'arrière / * Sobre la parte trasera

** Mit Zusatzhubausrüstungen / ** With additional lifting equipments / ** Avec équipements supplémentaires / ** Con equipos adicionales

Hubhöhen
Lifting heights
Hauteurs de levage
Alturas de elevación

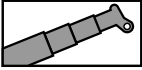

71t

DIN/ISO/EN

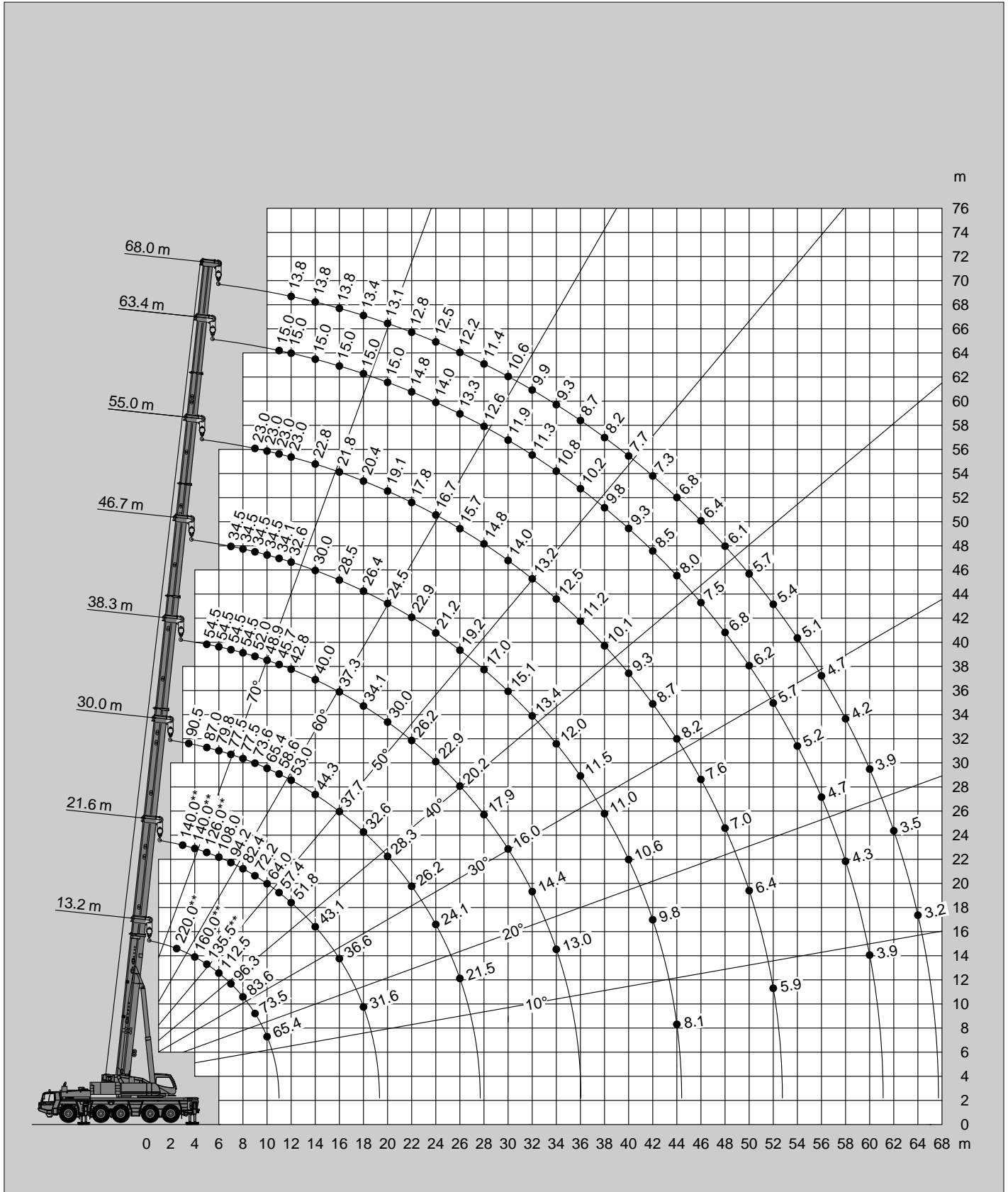

** Mit Zusatzhubausrüstungen / ** With additional lifting equipments / ** Avec équipements supplémentaires / ** Con equipos adicionales

Tragfähigkeiten
Lifting capacities
Capacités de levage
Capacidades de elevación

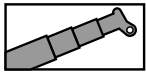

DIN/ISO/EN

→ m	13.2 m*	13.2 m	17.4 m	21.6 m	25.8 m	30.0 m	34.1 m	38.3 m	42.5 m	46.7 m	50.9 m	55.0 m	59.2 m	63.4 m	68.0 m
3.0	180.0**	174.5**	140.0**	140.0**	114.0**										
3.5	169.5**	157.0**	140.0**	140.0**	114.0**	90.5									
4.0	154.0**	142.5**	140.0**	140.0**	108.5	90.5									
4.5	137.0**	130.0**	130.0**	129.0**	103.5	90.5	70.0								
5.0	123.0**	119.5**	119.5**	118.5**	103.0	87.0	70.0	54.5							
6.0	102.0	102.0	102.0	101.0	101.5	79.8	70.0	54.5	43.5						
7.0	86.6	86.6	86.2	85.4	86.0	77.5	66.2	54.5	43.5	34.5					
8.0	74.7	74.7	74.3	73.5	74.1	74.9	61.2	54.5	43.5	34.5	28.5				
9.0	65.5	65.5	65.1	64.3	64.9	65.6	58.0	52.0	43.4	34.5	28.5	23.0			
10.0	58.2	58.2	57.7	56.9	57.5	58.2	58.0	48.9	41.4	34.5	28.5	23.0	18.8		
11.0			51.7	50.8	51.4	52.1	52.7	45.7	39.4	34.1	28.5	23.0	18.8	15.0	
12.0			46.5	45.4	46.2	47.0	47.2	42.8	37.6	32.6	28.3	23.0	18.8	15.0	13.8
14.0			36.0	34.8	35.6	36.5	38.7	38.6	35.6	30.0	26.8	22.8	18.8	15.0	13.8
16.0				28.3	30.2	32.5	32.2	31.4	30.6	28.5	24.9	21.8	18.8	15.0	13.8
18.0				26.2	27.4	27.1	26.8	26.0	25.2	25.0	23.1	20.4	18.3	15.0	13.4
20.0					23.3	23.1	22.7	21.9	21.4	20.9	21.1	19.1	17.2	15.0	13.1
22.0					20.2	19.9	19.5	18.7	19.4	17.7	17.9	17.8	16.2	14.8	12.8
24.0						17.4	16.9	16.1	16.8	15.4	15.9	15.7	15.2	14.0	12.5
26.0						15.3	14.8	14.0	14.7	14.6	14.4	14.2	14.0	13.3	12.2
28.0							13.1	12.3	13.0	13.4	12.6	12.8	12.4	12.6	11.4
30.0							11.6	10.8	11.5	11.9	11.2	11.4	11.7	11.1	10.6
32.0								9.6	10.2	10.6	10.5	10.8	10.4	9.8	9.8
34.0								8.8	9.6	9.7	9.8	9.7	9.3	8.7	8.7
36.0									9.1	9.1	9.2	8.8	8.3	7.7	7.7
38.0									8.7	8.5	8.3	7.9	7.4	6.9	6.8
40.0										7.8	7.5	7.1	6.6	6.1	6.1
42.0										7.1	6.8	6.4	6.0	5.4	5.4
44.0										6.6	6.2	5.8	5.3	4.8	4.8
46.0											5.7	5.2	4.8	4.2	4.2
48.0											5.2	4.7	4.3	3.7	3.7
50.0												4.3	3.8	3.3	3.2
52.0												3.9	3.4	2.8	2.8
54.0													3.0	2.5	2.4
56.0													2.7	2.1	2.1
58.0														1.8	1.7
60.0														1.5	1.4
62.0															1.2
64.0															0.9

* Nach hinten / * Over rear / * A l'arrière / * Sobre la parte trasera

** Mit Zusatzhubausrüstungen / ** With additional lifting equipments / ** Avec équipements supplémentaires / ** Con equipos adicionales

Hubhöhen
Lifting heights
Hauteurs de levage
Alturas de elevación

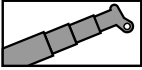

47t

DIN/ISO/EN

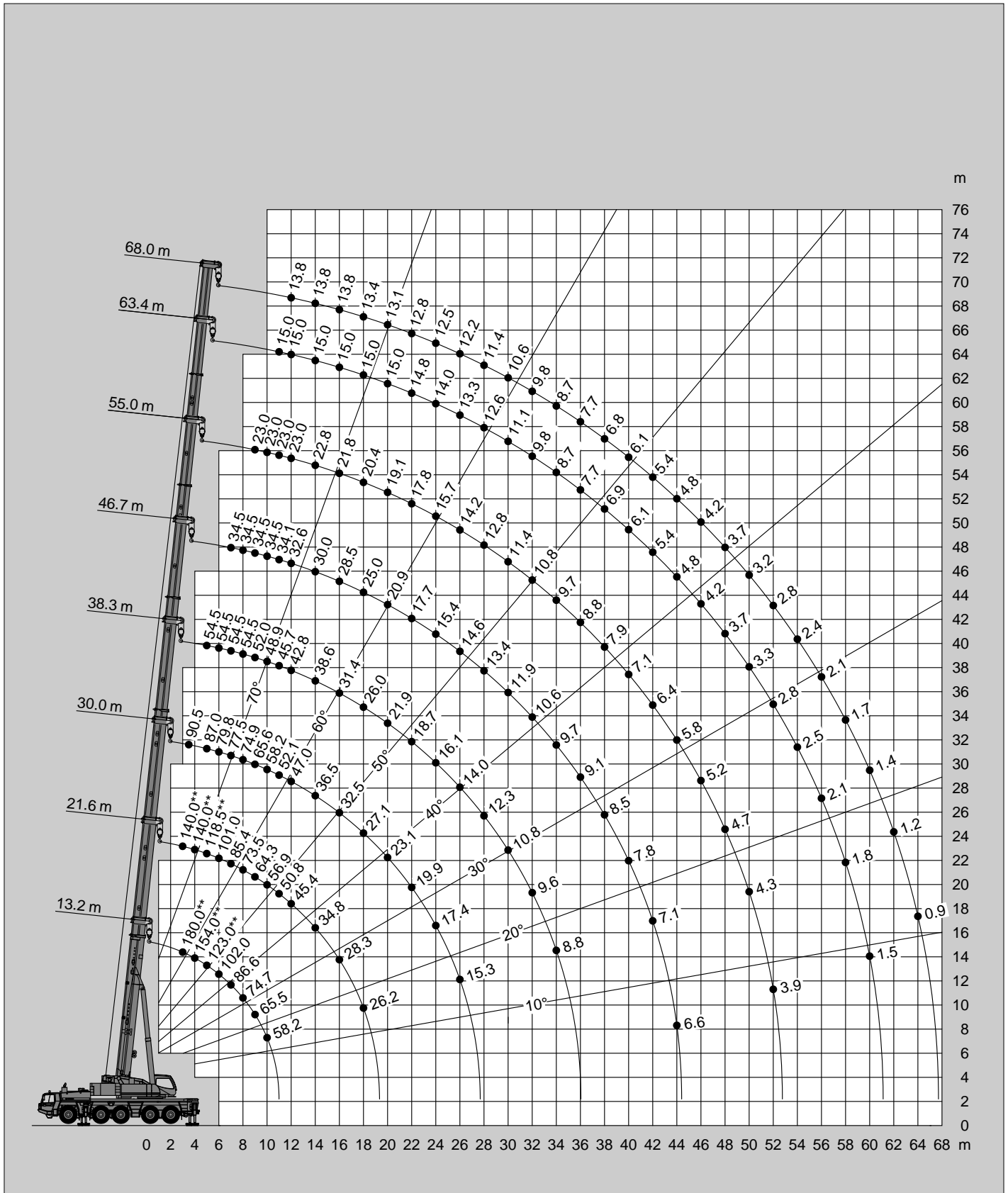

** Mit Zusatzhubausrüstungen / ** With additional lifting equipments / ** Avec équipements supplémentaires / ** Con equipos adicionales

Tragfähigkeiten
Lifting capacities
Capacités de levage
Capacidades de elevación

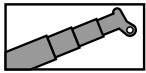

35 t

DIN/ISO/EN

 m	13.2 m*	13.2 m	17.4 m	21.6 m	25.8 m	30.0 m	34.1 m	38.3 m	42.5 m	46.7 m	50.9 m	55.0 m	59.2 m	63.4 m	68.0 m
3.0	180.0**	169.5**	140.0**	140.0**	114.0**										
3.5	166.5**	152.5**	140.0**	140.0**	114.0**	90.5									
4.0	146.0**	138.0**	138.0**	137.0**	108.5	90.5									
4.5	130.0**	126.0**	125.5**	124.5**	103.5	90.5	70.0								
5.0	117.0**	115.5**	115.0**	114.0**	103.0	87.0	70.0	54.5							
6.0	96.4	96.4	96.0	95.1	95.8	79.8	70.0	54.5	43.5						
7.0	81.4	81.4	81.0	80.2	80.8	77.5	66.2	54.5	43.5	34.5					
8.0	70.2	70.2	69.8	68.9	69.5	68.1	61.2	54.5	43.5	34.5	28.5				
9.0	61.5	61.5	61.0	60.2	59.9	58.2	57.0	52.0	43.4	34.5	28.5	23.0			
10.0	53.9	53.9	53.1	51.8	51.7	50.6	49.8	46.8	41.4	34.5	28.5	23.0	18.8		
11.0			44.8	43.5	44.4	44.5	44.0	43.5	39.4	34.1	28.5	23.0	18.8	15.0	
12.0			38.4	37.2	38.0	39.9	41.5	39.1	36.8	32.6	28.3	23.0	18.8	15.0	13.8
14.0			29.7	31.2	33.4	33.3	33.0	32.1	30.2	29.1	26.8	22.8	18.8	15.0	13.8
16.0				26.9	27.2	26.9	26.6	25.7	24.9	24.4	23.9	21.8	18.8	15.0	13.8
18.0				22.4	22.5	22.3	21.9	21.1	21.9	20.1	20.3	20.2	18.3	15.0	13.4
20.0					19.1	18.8	18.4	17.6	18.4	17.4	17.7	17.3	17.2	15.0	13.1
22.0					16.4	16.1	15.7	14.9	15.6	16.1	15.3	15.5	14.9	14.8	12.8
24.0						13.9	13.5	12.7	13.4	13.9	13.5	13.7	13.7	13.1	12.5
26.0						12.2	11.9	11.3	12.2	12.8	12.6	12.3	11.9	11.3	11.3
28.0							11.2	10.5	11.4	11.5	11.2	10.8	10.3	9.8	9.7
30.0							10.7	9.9	10.4	10.2	9.9	9.5	9.0	8.5	8.4
32.0								9.3	9.3	9.0	8.8	8.4	7.9	7.4	7.3
34.0								8.5	8.4	8.1	7.8	7.4	6.9	6.4	6.3
36.0									7.5	7.2	7.0	6.5	6.1	5.5	5.5
38.0									6.8	6.5	6.2	5.8	5.3	4.8	4.7
40.0										5.8	5.5	5.1	4.6	4.1	4.1
42.0										5.2	5.0	4.5	4.0	3.5	3.5
44.0										4.8	4.4	4.0	3.5	3.0	2.9
46.0											3.9	3.5	3.0	2.5	2.4
48.0											3.5	3.1	2.6	2.0	2.0
50.0												2.7	2.2	1.6	1.6
52.0												2.3	1.8	1.3	1.2
54.0													1.5		
56.0													1.3		

* Nach hinten / * Over rear / * A l'arrière / * Sobre la parte trasera

** Mit Zusatzhubausrüstungen / ** With additional lifting equipments / ** Avec équipements supplémentaires / ** Con equipos adicionales

Hubhöhen
Lifting heights
Hauteurs de levage
Alturas de elevación

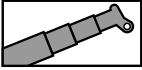

35t

DIN/ISO/EN

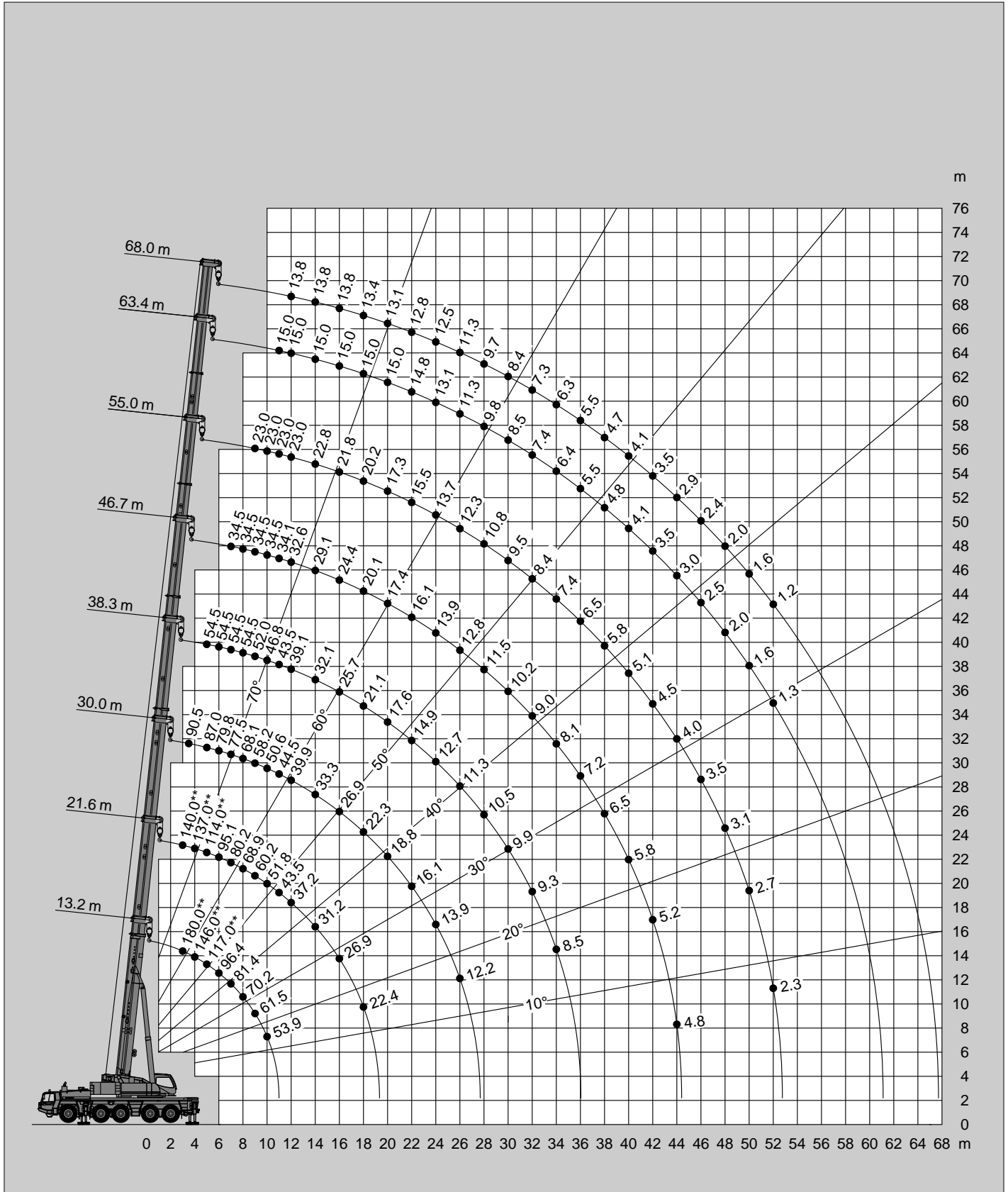

Tragfähigkeiten
Lifting capacities
Capacités de levage
Capacidades de elevación

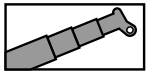

23.5 t

DIN/ISO/EN

 m	13.2 m*	13.2 m	17.4 m	21.6 m	25.8 m	30.0 m	34.1 m	38.3 m	42.5 m	46.7 m	50.9 m	55.0 m	59.2 m	63.4 m	68.0 m
3.0	180.0**	164.5**	140.0**	140.0**	114.0**										
3.5	158.0**	147.5**	140.0**	140.0**	114.0**	90.5									
4.0	138.5**	133.5**	133.0**	132.0**	108.5	90.5									
4.5	123.0**	121.5**	121.0**	120.0**	103.5	90.5	70.0								
5.0	110.0	110.0	110.0	109.0	103.0	87.0	70.0	54.5							
6.0	90.5	90.5	90.2	88.8	83.1	77.5	70.0	54.5	43.5						
7.0	76.4	76.4	76.0	69.9	66.3	63.5	58.7	54.5	43.5	34.5					
8.0	65.6	65.6	62.6	57.0	54.6	52.8	51.6	47.9	43.5	34.5	28.5				
9.0	53.0	53.0	52.2	47.7	46.0	45.5	46.6	43.5	39.2	34.5	28.5	23.0			
10.0	43.5	43.5	42.7	40.6	41.6	43.0	40.7	38.0	35.5	33.9	28.5	23.0	18.8		
11.0			35.8	36.9	39.7	37.9	36.0	33.6	31.4	30.0	28.5	23.0	18.8	15.0	
12.0			32.0	34.8	35.1	33.8	32.1	30.0	28.4	26.8	26.0	23.0	18.8	15.0	13.8
14.0			25.8	26.9	27.1	26.9	26.1	24.3	24.4	21.7	21.4	20.9	18.8	15.0	13.8
16.0				21.5	21.8	21.5	21.2	20.0	20.3	19.9	18.8	18.4	17.2	15.0	13.8
18.0				17.7	17.9	17.6	17.3	16.4	17.1	17.4	16.9	16.6	15.0	14.6	13.4
20.0					15.6	14.6	14.7	14.3	15.3	15.7	15.1	14.3	13.4	12.4	12.0
22.0					13.3	12.3	13.6	13.1	13.6	13.3	13.1	12.3	11.5	10.6	10.3
24.0						11.4	11.8	11.8	11.6	11.4	11.2	10.7	10.0	9.1	8.8
26.0						10.1	10.3	10.2	10.1	9.8	9.6	9.1	8.6	7.8	7.6
28.0							9.0	8.9	8.7	8.5	8.3	7.8	7.3	6.7	6.5
30.0							7.9	7.8	7.6	7.4	7.1	6.7	6.2	5.6	5.6
32.0								6.8	6.7	6.4	6.2	5.8	5.3	4.7	4.7
34.0								6.1	5.9	5.6	5.4	4.9	4.5	3.9	3.9
36.0									5.2	4.9	4.7	4.2	3.8	3.2	3.2
38.0									4.6	4.3	4.0	3.6	3.1	2.6	2.5
40.0										3.8	3.5	3.0	2.6	2.0	2.0
42.0										3.3	3.0	2.6	2.1	1.5	1.5
44.0										2.9	2.6	2.1	1.7	1.1	1.1
46.0											2.2	1.7	1.3		
48.0												1.9	1.4		

* Nach hinten / * Over rear / * A l'arrière / * Sobre la parte trasera

** Mit Zusatzhubausrüstungen / ** With additional lifting equipments / ** Avec équipements supplémentaires / ** Con equipos adicionales

Hubhöhen
Lifting heights
Hauteurs de levage
Alturas de elevación

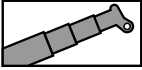

23.5t

DIN/ISO/EN

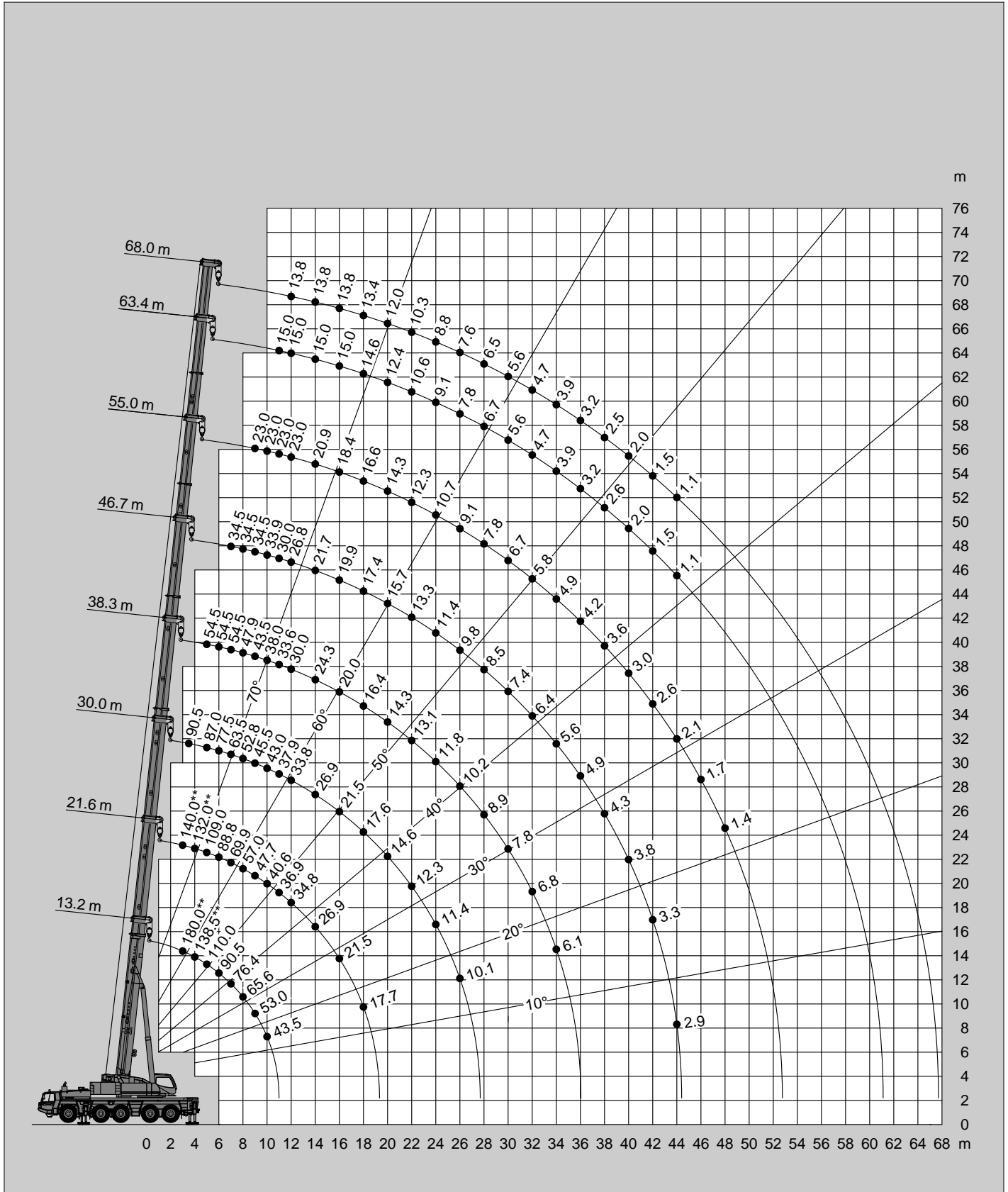

** Mit Zusatzhubausrüstungen / ** With additional lifting equipments / ** Avec équipements supplémentaires / ** Con equipos adicionales

Tragfähigkeiten
Lifting capacities
Capacités de levage
Capacidades de elevación

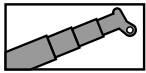

DIN/ISO/EN

 m	13.2 m*	13.2 m	17.4 m	21.6 m	25.8 m	30.0 m	34.1 m	38.3 m	42.5 m	46.7 m	50.9 m	55.0 m	59.2 m	63.4 m	68.0 m
3.0	173.5**	159.5**	140.0**	140.0**	114.0**										
3.5	149.5**	142.5**	140.0**	140.0**	114.0**	90.5									
4.0	131.0**	128.5**	128.0**	127.0**	108.5	90.5									
4.5	116.0**	115.5**	115.5**	114.5**	103.5	90.5	70.0								
5.0	103.5	103.0	103.0	99.8	91.5	81.6	70.0	54.5							
6.0	84.8	84.7	82.8	73.8	69.1	65.5	59.8	54.5	43.5						
7.0	69.3	69.3	64.1	57.7	54.8	52.6	51.1	47.0	43.5	34.5					
8.0	51.8	51.8	51.2	46.7	46.2	47.9	45.2	41.9	37.6	34.5	28.5				
9.0	40.8	40.8	40.1	41.3	43.5	41.2	38.8	36.0	33.3	31.7	28.5	23.0			
10.0	33.2	33.2	35.4	37.3	37.6	35.8	33.7	31.3	31.0	27.4	26.4	23.0	18.8		
11.0			30.1	31.4	31.7	31.4	29.6	27.3	27.2	23.8	23.1	22.7	18.8	15.0	
12.0			25.6	26.9	27.2	26.9	26.1	24.0	24.1	22.8	22.0	20.0	18.8	15.0	13.8
14.0			18.9	20.1	20.6	20.1	19.8	19.3	20.2	20.4	18.9	17.2	15.9	15.0	13.8
16.0				15.7	16.6	16.1	17.4	17.3	17.2	16.9	16.2	15.2	14.2	13.1	12.5
18.0				12.5	13.4	13.8	14.1	14.0	13.9	13.6	13.4	12.7	11.8	10.8	10.5
20.0					11.0	11.3	11.6	11.5	11.4	11.1	10.9	10.4	9.9	9.0	8.7
22.0					9.2	9.4	9.7	9.6	9.5	9.2	9.0	8.5	8.0	7.4	7.2
24.0						7.9	8.2	8.1	7.9	7.7	7.5	7.0	6.5	5.9	5.9
26.0						6.7	6.9	6.8	6.7	6.4	6.2	5.8	5.3	4.7	4.6
28.0							5.9	5.8	5.7	5.4	5.2	4.7	4.3	3.7	3.6
30.0							5.1	4.9	4.8	4.5	4.3	3.9	3.4	2.8	2.8
32.0								4.2	4.1	3.8	3.6	3.1	2.7	2.1	2.0
34.0								3.6	3.4	3.2	2.9	2.5	2.0	1.4	1.4
36.0									2.9	2.6	2.4	1.9	1.5		
38.0									2.5	2.1	1.9	1.4	1.0		
40.0										1.7	1.4	1.0			
42.0										1.3	1.1				
44.0										1.1					

* Nach hinten / * Over rear / * A l'arrière / * Sobre la parte trasera

** Mit Zusatzhubausrüstungen / ** With additional lifting equipments / ** Avec équipements supplémentaires / ** Con equipos adicionales

Hubhöhen
Lifting heights
Hauteurs de levage
Alturas de elevación

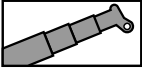

12t

DIN/ISO/EN

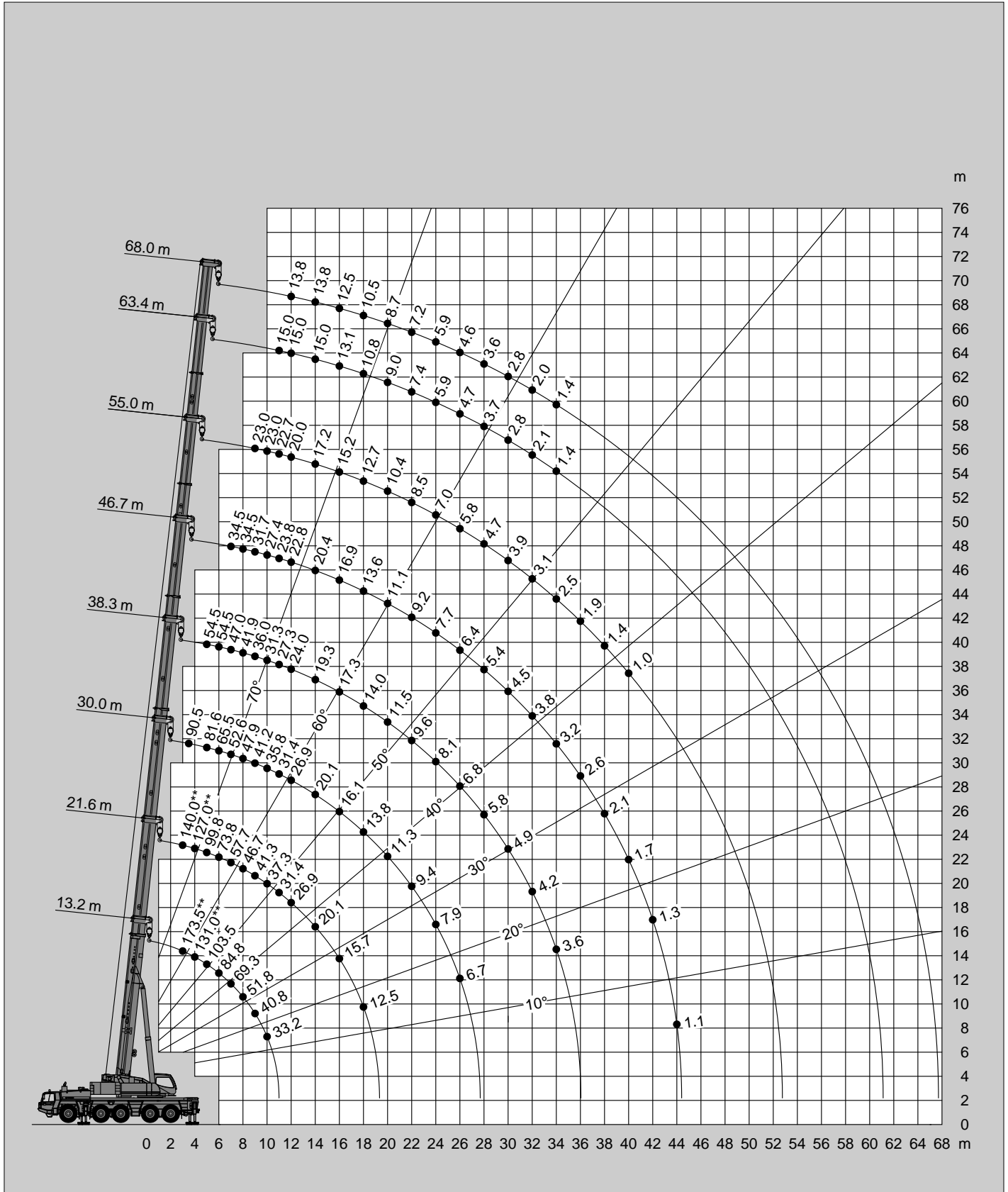

Tragfähigkeiten
Lifting capacities
Capacités de levage
Capacidades de elevación

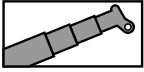

DIN/ISO/EN

 m	13.2 m*	13.2 m	17.4 m	21.6 m	25.8 m	30.0 m	34.1 m	38.3 m	42.5 m	46.7 m	50.9 m	55.0 m	59.2 m
3.0	163.5**	153.5**	140.0**	140.0**	114.0**								
3.5	141.0**	137.0**	136.5**	135.5**	114.0**	90.5							
4.0	122.5**	122.5**	122.0**	111.0**	98.1	84.5							
4.5	108.0	108.0	104.0	88.9	80.2	73.8	65.4						
5.0	96.4	96.4	85.0	73.5	67.4	62.9	58.0	53.4					
6.0	68.9	68.9	60.8	53.6	52.1	53.4	49.1	43.5	38.4				
7.0	52.1	52.1	46.5	46.6	46.2	43.0	39.6	35.7	32.2	30.0			
8.0	40.1	40.1	39.9	39.6	37.5	34.9	32.3	29.2	28.8	25.3	23.5		
9.0	30.9	30.9	33.1	32.5	31.1	29.1	27.0	26.0	25.1	23.8	21.6	19.3	
10.0	24.1	24.1	27.2	27.3	26.3	24.7	24.5	24.4	23.3	21.4	18.9	17.9	16.3
11.0			22.1	23.3	23.5	21.5	22.3	21.3	20.3	19.2	18.1	16.8	15.0
12.0			18.3	19.7	20.5	20.1	19.6	18.8	18.0	16.9	16.0	14.8	13.7
14.0			13.1	14.4	15.4	15.8	15.6	14.9	14.3	13.5	12.7	11.7	10.7
16.0				10.8	11.8	12.2	12.5	12.1	11.6	10.9	10.2	9.3	8.5
18.0				8.4	9.2	9.6	9.9	9.8	9.5	8.9	8.3	7.5	6.7
20.0					7.3	7.7	7.9	7.9	7.8	7.3	6.8	6.1	5.3
22.0					5.9	6.2	6.4	6.4	6.2	6.0	5.6	4.9	4.2
24.0						5.0	5.3	5.2	5.0	4.8	4.5	3.9	3.2
26.0						4.1	4.3	4.2	4.1	3.8	3.6	3.1	2.4
28.0							3.5	3.4	3.3	3.0	2.8	2.3	
30.0							2.9	2.7	2.6	2.3	2.1	1.6	
32.0								2.1	2.0	1.7	1.5		
34.0								1.7	1.5	1.2			
36.0									1.1				

* Nach hinten / * Over rear / * A l'arrière / * Sobre la parte trasera

** Mit Zusatzhubausrüstungen / ** With additional lifting equipments / ** Avec équipements supplémentaires / ** Con equipos adicionales

Hubhöhen
Lifting heights
Hauteurs de levage
Alturas de elevación

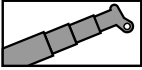

0t

DIN/ISO/EN

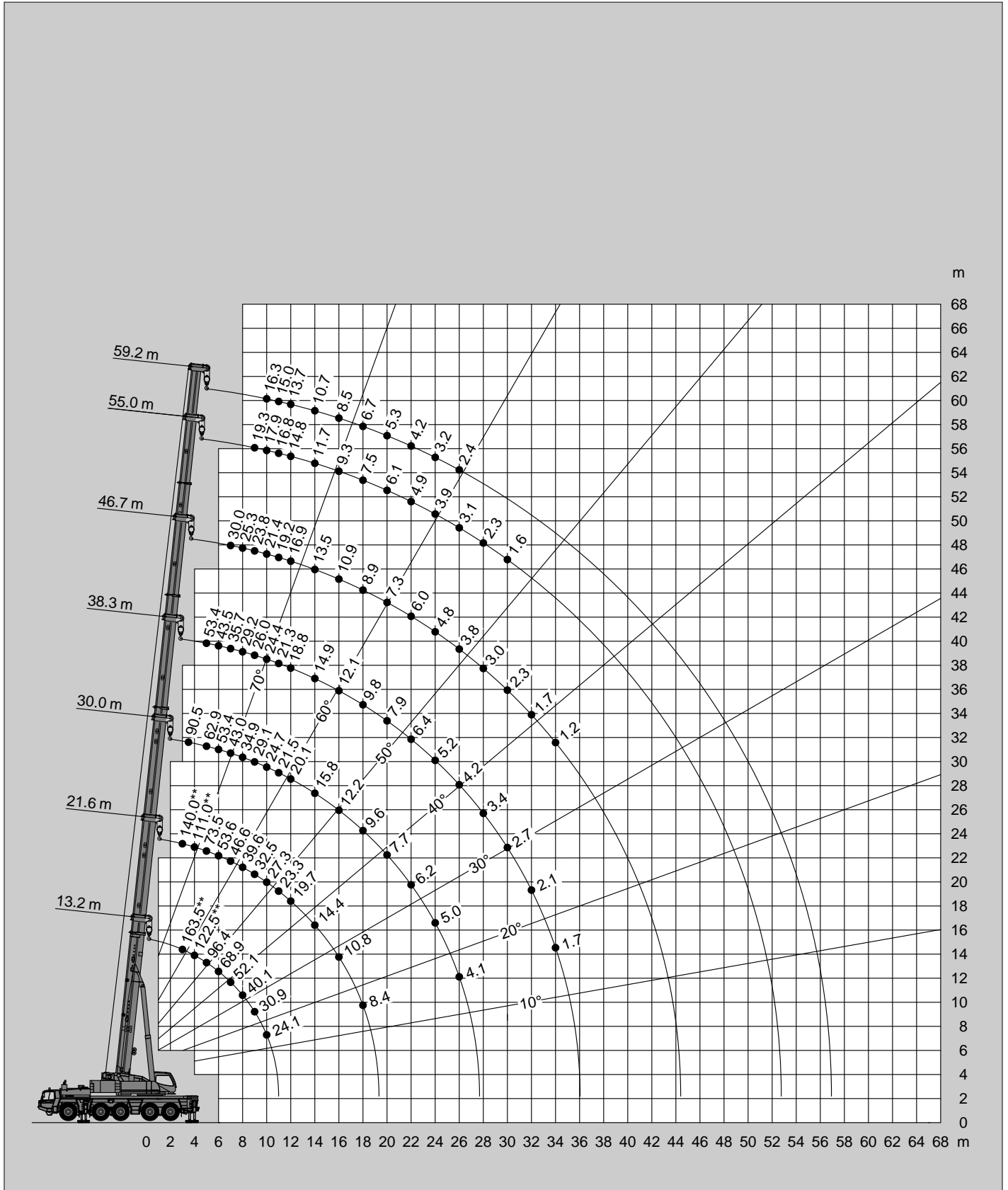

** Mit Zusatzhubausrüstungen / ** With additional lifting equipments / ** Avec équipements supplémentaires / ** Con equipos adicionales

Tragfähigkeiten
Lifting capacities
Capacités de levage
Capacidades de elevación

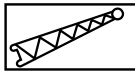
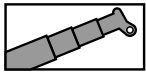

71t

DIN/ISO/EN

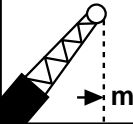
	13.2 m + 5.4 m			34.1 m + 5.4 m			63.4 m + 5.4 m			68.0 m + 5.4 m		
	0°	20°	40°	0°	20°	40°	0°	20°	40°	0°	20°	40°
3.0	47.5											
3.5	45.0	30.4										
4.0	42.6	29.4										
4.5	40.6	28.5										
5.0	38.7	27.6	22.2									
6.0	35.5	26.1	21.4	38.7								
7.0	32.8	24.8	20.7	38.7								
8.0	30.5	23.7	20.1	38.7	28.5							
9.0	28.5	22.7	19.6	38.7	27.7	21.5						
10.0	26.8	21.8	19.3	38.4	27.0	21.2						
11.0	25.2	21.1	18.7	36.4	26.3	20.9						
12.0	23.7	20.1	18.3	34.5	25.6	20.6						
14.0	20.7	18.5		31.2	24.5	20.1	10.9			9.2		
16.0	18.1			28.3	23.5	19.6	10.3	9.6	9.2	9.2	8.8	
18.0				25.9	22.6	19.2	9.8	9.1	8.8	8.9	8.4	8.1
20.0				23.8	21.8	18.9	9.3	8.7	8.4	8.5	8.0	7.7
22.0				22.0	21.1	18.5	8.9	8.3	8.1	8.1	7.7	7.4
24.0				20.4	20.1	18.1	8.5	8.0	7.7	7.8	7.4	7.1
26.0				18.0	18.5	17.9	8.1	7.7	7.4	7.5	7.1	6.9
28.0				15.8	16.2	16.3	7.8	7.5	7.2	7.2	6.9	6.7
30.0				13.9	14.2	14.3	7.5	7.2	7.0	6.9	6.6	6.5
32.0				12.3	12.5		7.2	7.0	6.8	6.6	6.4	6.3
34.0				10.9	11.1		7.0	6.7	6.6	6.4	6.2	6.1
36.0				9.7			6.7	6.5	6.4	6.2	6.0	5.9
38.0							6.5	6.3	6.2	6.0	5.8	5.7
40.0							6.3	6.1	6.0	5.8	5.6	5.5
44.0							6.0	5.8	5.7	5.5	5.3	5.2
48.0							5.4	5.4	5.4	5.2	5.1	5.0
52.0							4.9	4.9	4.9	4.7	4.7	4.7
56.0							4.3	4.4		4.3	4.3	4.3
60.0							3.6	3.6		3.6	3.6	
64.0							2.9			2.9	2.9	
68.0										2.3		

Hubhöhen
Lifting heights
Hauteurs de levage
Alturas de elevación

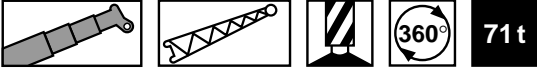

DIN/ISO/EN

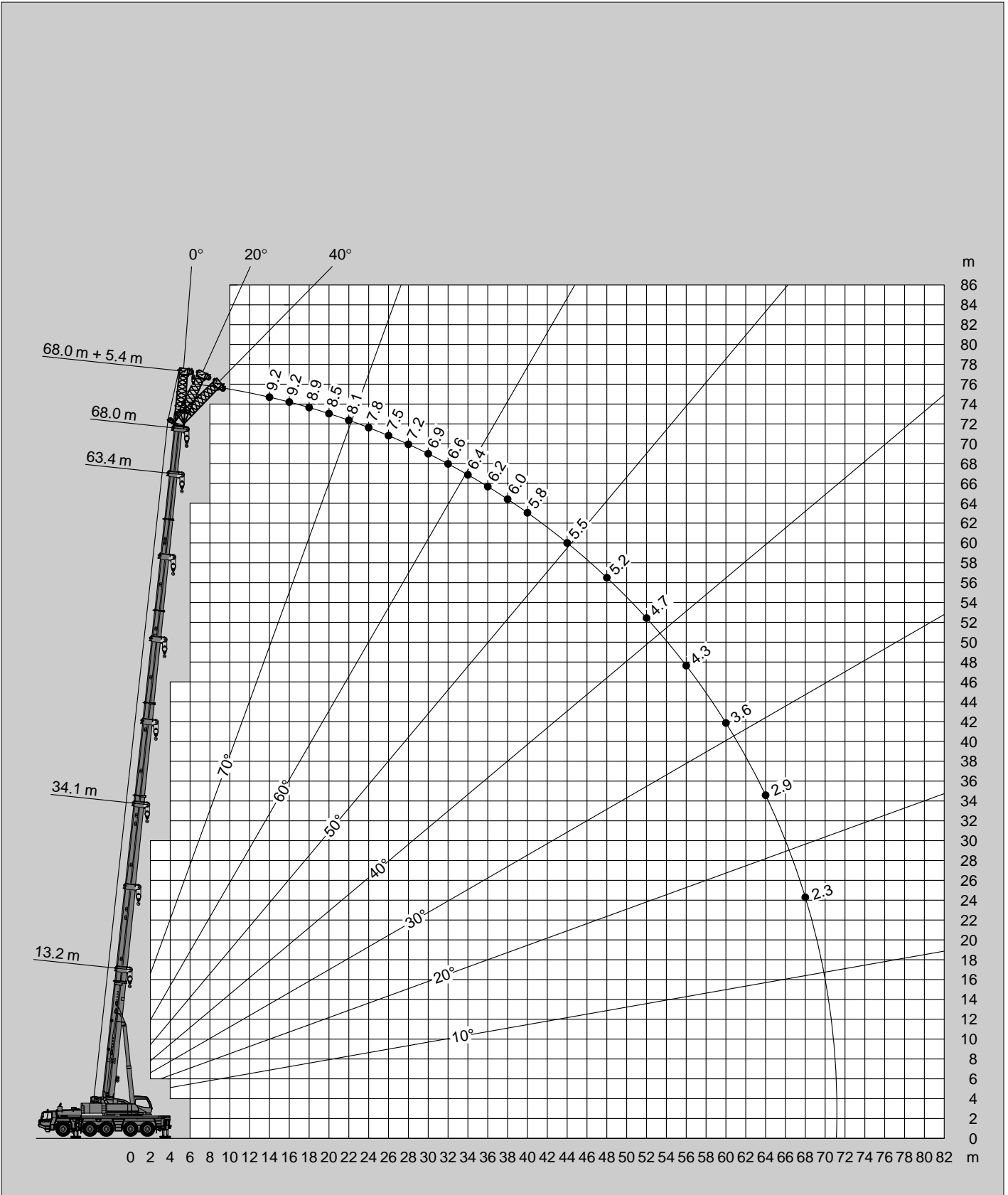

Tragfähigkeiten
Lifting capacities
Capacités de levage
Capacidades de elevación

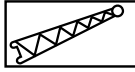
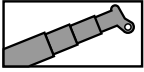

DIN/ISO/EN

m	68.0 m + 13.2 m			68.0 m + 19.2 m			68.0 m + 25.2 m			68.0 m + 31.2 m			68.0 m + 37.2 m		
	0°	20°	40°	0°	20°	40°	0°	20°	40°	0°	20°	40°	0°		
14.0	5.9														
16.0	5.9			4.6											
18.0	5.9			4.6											
20.0	5.9	5.9		4.6			3.6			2.8			2.3		
22.0	5.9	5.9		4.6			3.6			2.8			2.3		
24.0	5.9	5.8	5.4	4.6	4.6		3.6			2.8			2.3		
26.0	5.9	5.6	5.2	4.6	4.6		3.6			2.8			2.3		
28.0	5.9	5.4	5.0	4.6	4.4		3.6	3.6		2.8			2.3		
30.0	5.7	5.2	4.9	4.6	4.3	3.9	3.6	3.6		2.8			2.3		
32.0	5.5	5.0	4.7	4.6	4.1	3.8	3.6	3.4		2.8			2.3		
34.0	5.3	4.8	4.6	4.5	4.0	3.7	3.6	3.3		2.8	2.7		2.3		
36.0	5.2	4.7	4.5	4.3	3.9	3.6	3.6	3.2	3.0	2.8	2.6		2.3		
38.0	5.0	4.5	4.3	4.2	3.8	3.5	3.5	3.1	2.9	2.8	2.6		2.3		
40.0	4.8	4.4	4.2	4.0	3.6	3.4	3.4	3.0	2.8	2.8	2.5		2.3		
44.0	4.5	4.2	4.0	3.8	3.4	3.2	3.2	2.8	2.6	2.7	2.3	2.1	2.2		
48.0	4.3	4.0	3.8	3.6	3.2	3.1	3.0	2.7	2.5	2.5	2.2	2.0	2.1		
52.0	4.0	3.8	3.7	3.4	3.1	2.9	2.8	2.5	2.4	2.3	2.0	1.9	1.9		
56.0	3.8	3.6	3.5	3.2	2.9	2.8	2.6	2.4	2.3	2.1	1.9	1.8	1.8		
60.0	3.6	3.5	3.4	3.0	2.8	2.7	2.5	2.2	2.2	2.0	1.8	1.7	1.7		
64.0	3.2	3.3	3.3	2.9	2.7	2.6	2.4	2.1	2.1	1.9	1.7	1.6	1.5		
68.0	2.7	2.9		2.7	2.6	2.5	2.3	2.1	2.0	1.8	1.6	1.5	1.4		
72.0	2.2	2.3		2.4	2.5	2.5	2.1	2.0	1.9	1.7	1.5	1.4	1.3		
76.0	1.7	1.8		1.9	2.1		1.9	1.9	1.8	1.6	1.4	1.3			
80.0				1.5	1.6		1.5	1.8		1.4	1.3				
84.0								1.4							

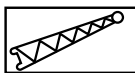
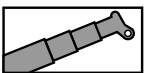

DIN/ISO/EN

m	63.4 m + 13.2 m			63.4 m + 19.2 m			63.4 m + 25.2 m			63.4 m + 31.2 m			63.4 m + 37.2 m		
	0°	20°	40°	0°	20°	40°	0°	20°	40°	0°	20°	40°	0°	20°	
14.0	6.8			5.2											
16.0	6.8			5.2			4.0			3.2					
18.0	6.8			5.2			4.0			3.2			2.5		
20.0	6.8	6.7		5.2			4.0			3.2			2.5		
22.0	6.8	6.4		5.2	5.2		4.0			3.2			2.5		
24.0	6.8	6.2	5.7	5.2	5.1		4.0			3.2			2.5		
26.0	6.7	6.0	5.5	5.2	4.9		4.0	4.0		3.2			2.5		
28.0	6.4	5.8	5.4	5.2	4.7		4.0	3.9		3.2			2.5		
30.0	6.2	5.6	5.2	5.2	4.5	4.2	4.0	3.8		3.2	3.0		2.5		
32.0	5.9	5.4	5.0	5.0	4.4	4.1	4.0	3.6		3.2	3.0		2.5		
34.0	5.7	5.2	4.9	4.8	4.3	3.9	4.0	3.5	3.2	3.2	2.9		2.5	2.1	
36.0	5.5	5.0	4.8	4.6	4.1	3.8	3.9	3.4	3.1	3.2	2.8		2.5	2.1	
38.0	5.4	4.9	4.6	4.5	4.0	3.7	3.8	3.3	3.0	3.2	2.7		2.4	2.0	
40.0	5.2	4.7	4.5	4.3	3.9	3.6	3.7	3.2	3.0	3.1	2.6	2.4	2.4	2.0	
44.0	4.9	4.5	4.3	4.1	3.7	3.4	3.4	3.0	2.8	2.8	2.4	2.3	2.3	1.9	
48.0	4.6	4.3	4.1	3.8	3.5	3.3	3.2	2.8	2.7	2.7	2.3	2.1	2.2	1.8	
52.0	4.4	4.1	4.0	3.6	3.3	3.2	3.0	2.7	2.5	2.5	2.2	2.0	2.1	1.7	
56.0	4.0	3.9	3.9	3.5	3.1	3.0	2.8	2.6	2.4	2.3	2.0	1.9	1.9	1.6	
60.0	3.7	3.7	3.6	3.3	3.0	2.9	2.7	2.4	2.3	2.2	1.9	1.8	1.8	1.5	
64.0	3.4	3.4		3.0	2.9	2.8	2.6	2.3	2.2	2.0	1.8	1.7	1.7	1.4	
68.0	2.8	3.0		2.8	2.7	2.7	2.4	2.2	2.1	1.9	1.7	1.6	1.5	1.4	
72.0	2.3	2.4		2.4	2.5		2.2	2.1	2.0	1.8	1.6	1.5	1.4	1.3	
76.0				2.0	2.1		2.0	2.0		1.6	1.5	1.4	1.3		
80.0							1.7	1.9		1.5	1.4	1.3			
84.0							1.3	1.4		1.3	1.3				

Hubhöhen
Lifting heights
Hauteurs de levage
Alturas de elevación

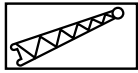
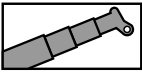

71t

DIN/ISO/EN

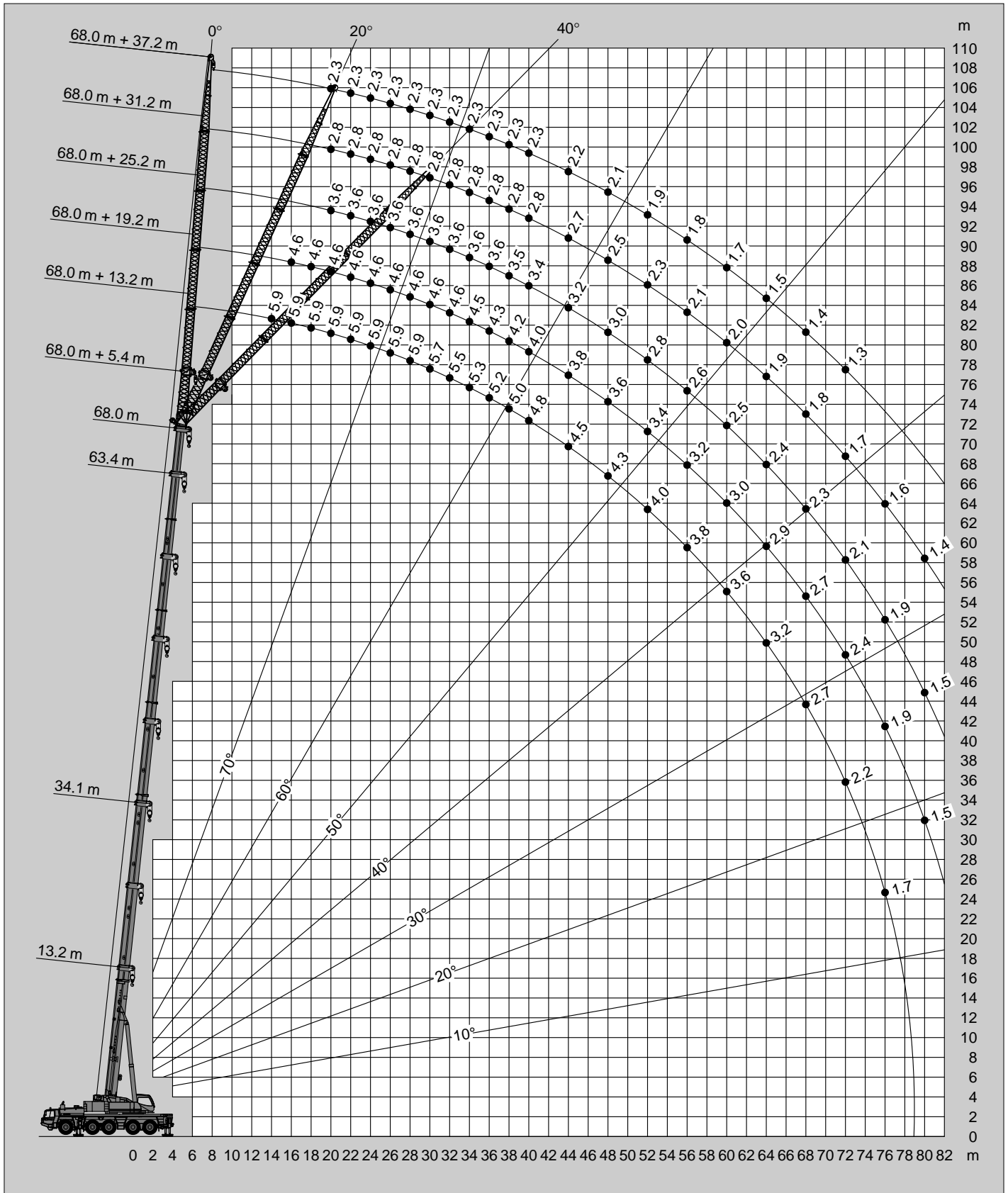

Tragfähigkeiten
Lifting capacities
Capacités de levage
Capacidades de elevación

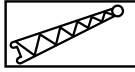
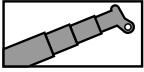

71t

DIN/ISO/EN

m	34.1 m + 13.2 m			34.1 m + 19.2 m			34.1 m + 25.2 m			34.1 m + 31.2 m			34.1 m + 37.2 m		
	0°	20°	40°	0°	20°	40°	0°	20°	40°	0°	20°	40°	0°	20°	40°
6.0	17.9														
7.0	17.2			13.1											
8.0	16.4			13.1			8.9								
9.0	15.8			13.1			8.9			5.7					
10.0	15.1			12.9			8.9			5.7			4.1		
11.0	14.5	10.4		12.6			8.9			5.7			4.1		
12.0	14.0	10.2		12.3			8.9			5.7			4.1		
14.0	13.0	9.6		11.6			8.8			5.7			4.1		
16.0	12.1	9.1	7.6	10.9	8.2		8.4			5.7			4.1		
18.0	11.4	8.7	7.3	10.3	7.8		7.9			5.7			4.1		
20.0	10.7	8.3	7.1	9.7	7.4	5.8	7.5	5.7		5.7			4.1		
22.0	10.1	8.0	6.9	9.1	7.1	5.6	7.1	5.4		5.4			4.1		
24.0	9.6	7.7	6.8	8.7	6.8	5.4	6.7	5.2		5.2	4.1		3.9		
26.0	9.1	7.5	6.6	8.2	6.5	5.2	6.3	5.0		5.0	3.9		3.8		
28.0	8.7	7.2	6.5	7.8	6.2	5.0	6.0	4.8	3.8	4.7	3.7		3.6		
30.0	8.3	7.0	6.4	7.5	5.9	4.9	5.7	4.6	3.7	4.5	3.6		3.4	2.8	
32.0	7.9	6.8	6.3	7.1	5.6	4.7	5.5	4.4	3.5	4.3	3.4	2.7	3.3	2.7	
34.0	7.6	6.7	6.3	6.8	5.4	4.6	5.2	4.2	3.4	4.1	3.3	2.6	3.2	2.6	
36.0	7.4	6.5	6.3	6.4	5.2	4.5	5.0	4.0	3.3	3.9	3.1	2.5	3.0	2.5	
38.0	7.1	6.4		6.0	4.9	4.4	4.8	3.8	3.2	3.8	2.9	2.4	2.9	2.4	1.8
40.0	6.9	6.3		5.7	4.8	4.3	4.5	3.6	3.1	3.6	2.8	2.3	2.8	2.2	1.8
44.0	6.7			5.1	4.5		4.0	3.4	3.0	3.2	2.6	2.2	2.6	2.0	1.6
48.0				4.6	4.3		3.6	3.1	2.9	2.8	2.4	2.1	2.3	1.8	1.5
52.0							3.2	2.9		2.5	2.2	2.0	2.0	1.7	1.4
56.0							2.9			2.3	2.0		1.8	1.5	1.4
60.0										2.0	1.9		1.6	1.4	1.3
64.0													1.5	1.3	
68.0													1.3		

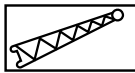
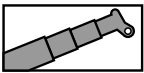

71t

DIN/ISO/EN

m	13.2 m + 13.2 m			13.2 m + 19.2 m			13.2 m + 25.2 m			13.2 m + 31.2 m			13.2 m + 37.2 m		
	0°	20°	40°	0°	20°	40°	0°	20°	40°	0°	20°	40°	0°	20°	40°
3.0	18.0														
3.5	18.0			16.0											
4.0	18.0			15.7			10.4								
4.5	17.4			15.4			10.4								
5.0	16.7			15.0			10.4			6.4					
6.0	15.4			14.3			10.4			6.4			4.6		
7.0	14.4	11.5		13.6			10.4			6.4			4.6		
8.0	13.4	10.9		13.0			10.4			6.4			4.6		
9.0	12.6	10.3		12.4			10.0			6.4			4.6		
10.0	11.9	9.8		11.7			9.5			6.4			4.6		
11.0	11.2	9.4		11.1	9.0		9.0			6.4			4.6		
12.0	10.6	9.0	7.9	10.5	8.6		8.6			6.4			4.6		
14.0	9.6	8.3	7.4	9.5	7.9		7.8			6.3			4.6		
16.0	8.8	7.8	7.1	8.7	7.1	5.9	7.1	6.0		5.8			4.5		
18.0	8.1	7.3	6.8	7.8	6.5	5.5	6.5	5.6		5.4			4.2		
20.0	7.5	6.9	6.7	7.0	5.9	5.2	6.0	5.0		5.0			4.0		
22.0	7.1	6.7		6.3	5.5	4.9	5.5	4.6		4.6	3.9		3.7		
24.0				5.7	5.1	4.6	4.9	4.2		4.3	3.6		3.5	3.1	
26.0				5.2	4.7	4.4	4.5	3.9	3.5	3.8	3.3		3.3	2.9	
28.0				4.7	4.5		4.1	3.6	3.3	3.5	3.0		3.1	2.6	
30.0							3.7	3.4	3.1	3.2	2.8		2.8	2.4	
32.0							3.4	3.2	3.0	2.9	2.6	2.4	2.5	2.2	
34.0							3.2	3.0		2.7	2.4	2.2	2.3	2.1	
36.0							2.9			2.5	2.3	2.1	2.1	1.9	1.7
38.0										2.3	2.2	2.0	2.0	1.8	1.6
40.0										2.1	2.0		1.8	1.7	1.5
44.0													1.5	1.5	1.4
48.0													1.3	1.3	

Hubhöhen
Lifting heights
Hauteurs de levage
Alturas de elevación

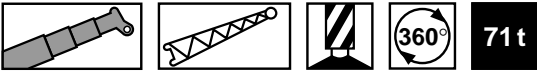

DIN/ISO/EN

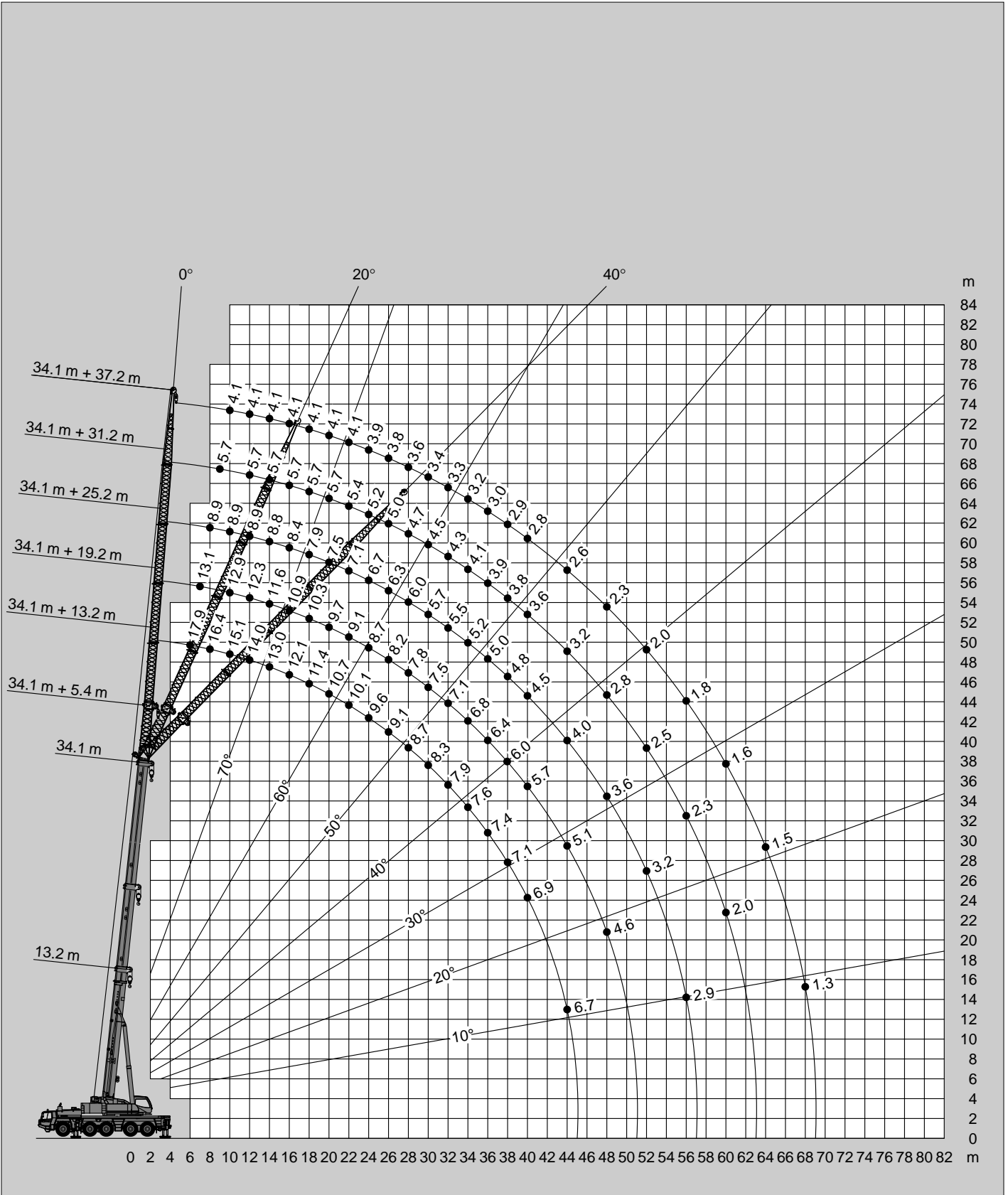

Tragfähigkeiten
Lifting capacities
Capacités de levage
Capacidades de elevación

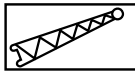
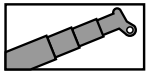

47t

DIN/ISO/EN

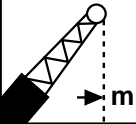
	13.2 m + 5.4 m			34.1 m + 5.4 m			63.4 m + 5.4 m			68.0 m + 5.4 m		
	0°	20°	40°	0°	20°	40°	0°	20°	40°	0°	20°	40°
3.0	47.5											
3.5	45.0	30.4										
4.0	42.6	29.4										
4.5	40.6	28.5										
5.0	38.7	27.6	22.2									
6.0	35.5	26.1	21.4	38.7								
7.0	32.8	24.8	20.7	38.7								
8.0	30.5	23.7	20.1	38.7	28.5							
9.0	28.5	22.7	19.6	38.7	27.7	21.5						
10.0	26.8	21.8	19.3	38.4	27.0	21.2						
11.0	25.2	21.1	18.7	36.4	26.3	20.9						
12.0	23.7	20.1	18.3	34.5	25.6	20.6						
14.0	20.7	18.5		31.2	24.5	20.1	10.9			9.2		
16.0	18.1			28.3	23.5	19.6	10.3	9.6	9.2	9.2	8.8	
18.0				23.6	22.6	19.2	9.8	9.1	8.8	8.9	8.4	8.1
20.0				19.6	20.3	18.9	9.3	8.7	8.4	8.5	8.0	7.7
22.0				16.4	17.0	17.4	8.9	8.3	8.1	8.1	7.7	7.4
24.0				13.9	14.4	14.7	8.5	8.0	7.7	7.8	7.4	7.1
26.0				11.8	12.2	12.5	8.1	7.7	7.4	7.5	7.1	6.9
28.0				10.1	10.4	10.6	7.8	7.5	7.2	7.2	6.9	6.7
30.0				8.6	8.9	9.0	7.5	7.2	7.0	6.9	6.6	6.5
32.0				7.4	7.6		7.2	7.0	6.8	6.6	6.4	6.3
34.0				6.3	6.4		7.0	6.7	6.6	6.4	6.2	6.1
36.0				5.4			6.7	6.5	6.4	6.2	6.0	5.9
38.0							6.3	6.3	6.2	6.0	5.8	5.7
40.0							5.5	5.7	5.9	5.7	5.6	5.5
44.0							4.2	4.4	4.5	4.3	4.6	4.7
48.0							3.2	3.3	3.4	3.3	3.5	3.5
52.0							2.3	2.5	2.5	2.4	2.5	2.6
56.0							1.6	1.7		1.7	1.8	1.8

Hubhöhen
Lifting heights
Hauteurs de levage
Alturas de elevación

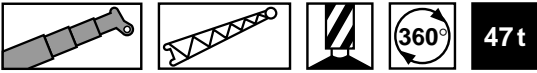

DIN/ISO/EN

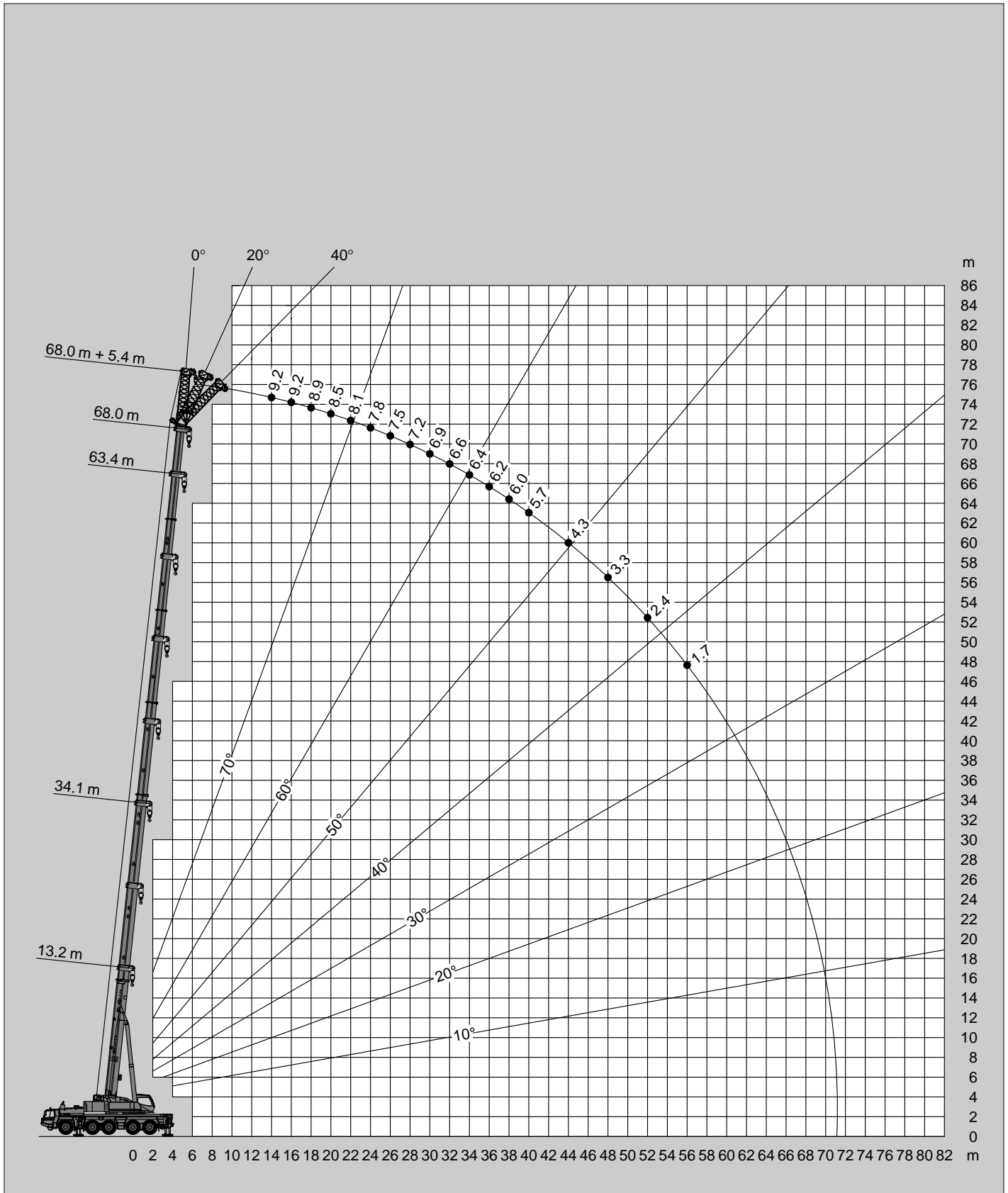

Tragfähigkeiten
Lifting capacities
Capacités de levage
Capacidades de elevación

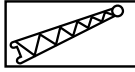
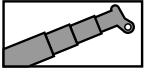

47t

DIN/ISO/EN

m	68.0 m + 13.2 m			68.0 m + 19.2 m			68.0 m + 25.2 m			68.0 m + 31.2 m			68.0 m + 37.2 m		
	0°	20°	40°	0°	20°	40°	0°	20°	40°	0°	20°	40°	0°		
14.0	5.9														
16.0	5.9			4.6											
18.0	5.9			4.6											
20.0	5.9	5.9		4.6			3.6			2.8			2.3		
22.0	5.9	5.9		4.6			3.6			2.8			2.3		
24.0	5.9	5.8	5.4	4.6	4.6		3.6			2.8			2.3		
26.0	5.9	5.6	5.2	4.6	4.6		3.6			2.8			2.3		
28.0	5.9	5.4	5.0	4.6	4.4		3.6	3.6		2.8			2.3		
30.0	5.7	5.2	4.9	4.6	4.3	3.9	3.6	3.6		2.8			2.3		
32.0	5.5	5.0	4.7	4.6	4.1	3.8	3.6	3.4		2.8			2.3		
34.0	5.3	4.8	4.6	4.5	4.0	3.7	3.6	3.3		2.8	2.7		2.3		
36.0	5.2	4.7	4.5	4.3	3.9	3.6	3.6	3.2	3.0	2.8	2.6		2.3		
38.0	5.0	4.5	4.3	4.2	3.8	3.5	3.5	3.1	2.9	2.8	2.6		2.3		
40.0	4.8	4.4	4.2	4.0	3.6	3.4	3.4	3.0	2.8	2.8	2.5		2.3		
44.0	4.5	4.2	4.0	3.8	3.4	3.2	3.2	2.8	2.6	2.7	2.3	2.1	2.2		
48.0	3.8	4.0	3.8	3.6	3.2	3.1	3.0	2.7	2.5	2.5	2.2	2.0	2.1		
52.0	2.9	3.3	3.6	3.2	3.1	2.9	2.8	2.5	2.4	2.3	2.0	1.9	1.9		
56.0	2.2	2.5	2.8	2.5	2.9	2.8	2.6	2.4	2.3	2.1	1.9	1.8	1.8		
60.0	1.5	1.8	2.0	1.8	2.3	2.6	1.9	2.2	2.2	1.9	1.8	1.7	1.7		
64.0		1.2	1.4	1.2	1.6	1.9	1.3	1.9	2.1	1.3	1.7	1.6	1.4		
68.0						1.3		1.3	1.7		1.5	1.5			
72.0											1.4	1.4			

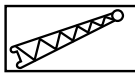
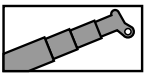

47t

DIN/ISO/EN

m	63.4 m + 13.2 m			63.4 m + 19.2 m			63.4 m + 25.2 m			63.4 m + 31.2 m			63.4 m + 37.2 m		
	0°	20°	40°	0°	20°	40°	0°	20°	40°	0°	20°	40°	0°	20°	
14.0	6.8			5.2											
16.0	6.8			5.2			4.0			3.2					
18.0	6.8			5.2			4.0			3.2			2.5		
20.0	6.8	6.7		5.2			4.0			3.2			2.5		
22.0	6.8	6.4		5.2	5.2		4.0			3.2			2.5		
24.0	6.8	6.2	5.7	5.2	5.1		4.0			3.2			2.5		
26.0	6.7	6.0	5.5	5.2	4.9		4.0	4.0		3.2			2.5		
28.0	6.4	5.8	5.4	5.2	4.7		4.0	3.9		3.2			2.5		
30.0	6.2	5.6	5.2	5.2	4.5	4.2	4.0	3.8		3.2	3.0		2.5		
32.0	5.9	5.4	5.0	5.0	4.4	4.1	4.0	3.6		3.2	3.0		2.5		
34.0	5.7	5.2	4.9	4.8	4.3	3.9	4.0	3.5	3.2	3.2	2.9		2.5	2.1	
36.0	5.5	5.0	4.8	4.6	4.1	3.8	3.9	3.4	3.1	3.2	2.8		2.5	2.1	
38.0	5.4	4.9	4.6	4.5	4.0	3.7	3.8	3.3	3.0	3.2	2.7		2.4	2.0	
40.0	5.2	4.7	4.5	4.3	3.9	3.6	3.7	3.2	3.0	3.1	2.6	2.4	2.4	2.0	
44.0	4.9	4.5	4.3	4.1	3.7	3.4	3.4	3.0	2.8	2.8	2.4	2.3	2.3	1.9	
48.0	3.9	4.3	4.1	3.8	3.5	3.3	3.2	2.8	2.7	2.7	2.3	2.1	2.2	1.8	
52.0	3.0	3.4	3.7	3.2	3.3	3.2	3.0	2.7	2.5	2.5	2.2	2.0	2.1	1.7	
56.0	2.3	2.6	2.8	2.4	3.0	3.0	2.7	2.6	2.4	2.3	2.0	1.9	1.9	1.6	
60.0	1.6	1.9	2.1	1.8	2.2	2.5	2.0	2.4	2.3	2.1	1.9	1.8	1.8	1.5	
64.0		1.3		1.2	1.6	1.8	1.5	2.0	2.2	1.5	1.8	1.7	1.6	1.4	
68.0						1.2		1.4	1.7		1.6	1.6		1.4	
72.0											1.4	1.4		1.3	

Hubhöhen
Lifting heights
Hauteurs de levage
Alturas de elevación

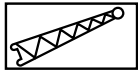
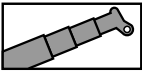

47t

DIN/ISO/EN

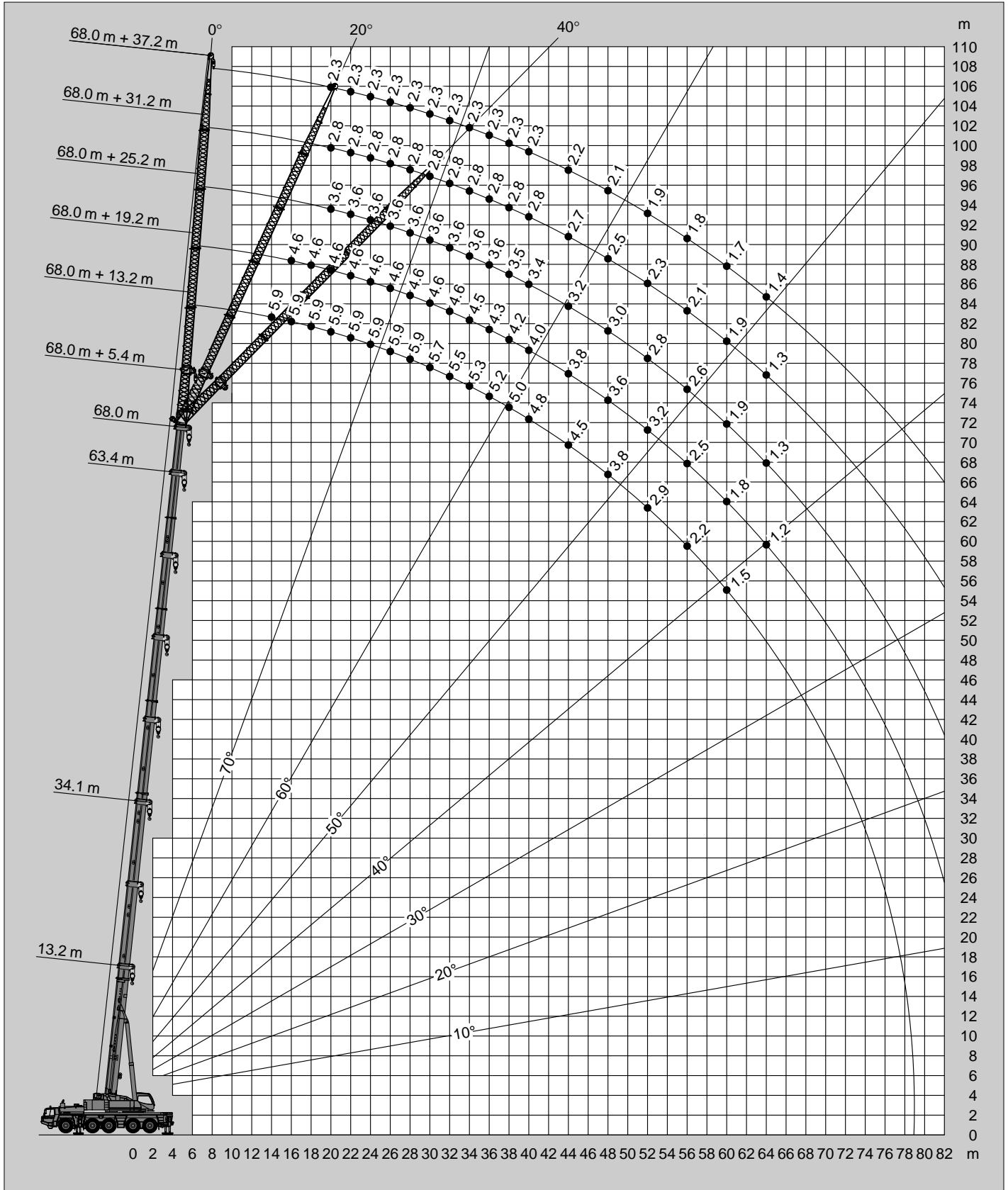

Tragfähigkeiten
Lifting capacities
Capacités de levage
Capacidades de elevación

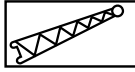
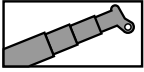

47t

DIN/ISO/EN

m	34.1 m + 13.2 m			34.1 m + 19.2 m			34.1 m + 25.2 m			34.1 m + 31.2 m			34.1 m + 37.2 m		
	0°	20°	40°	0°	20°	40°	0°	20°	40°	0°	20°	40°	0°	20°	40°
6.0	17.9														
7.0	17.2			13.1											
8.0	16.4			13.1			8.9								
9.0	15.8			13.1			8.9			5.7					
10.0	15.1			12.9			8.9			5.7			4.1		
11.0	14.5	10.4		12.6			8.9			5.7			4.1		
12.0	14.0	10.2		12.3			8.9			5.7			4.1		
14.0	13.0	9.6		11.6			8.8			5.7			4.1		
16.0	12.1	9.1	7.6	10.9	8.2		8.4			5.7			4.1		
18.0	11.4	8.7	7.3	10.3	7.8		7.9			5.7			4.1		
20.0	10.7	8.3	7.1	9.7	7.4	5.8	7.5	5.7		5.7			4.1		
22.0	10.1	8.0	6.9	9.1	7.1	5.6	7.1	5.4		5.4			4.1		
24.0	9.6	7.7	6.8	8.7	6.8	5.4	6.7	5.2		5.2	4.1		3.9		
26.0	9.1	7.5	6.6	8.2	6.5	5.2	6.3	5.0		5.0	3.9		3.8		
28.0	8.7	7.2	6.5	7.8	6.2	5.0	6.0	4.8	3.8	4.7	3.7		3.6		
30.0	8.3	7.0	6.4	7.5	5.9	4.9	5.7	4.6	3.7	4.5	3.6		3.4	2.8	
32.0	7.9	6.8	6.3	7.1	5.6	4.7	5.5	4.4	3.5	4.3	3.4	2.7	3.3	2.7	
34.0	7.6	6.7	6.3	6.8	5.4	4.6	5.2	4.2	3.4	4.1	3.3	2.6	3.2	2.6	
36.0	6.8	6.5	6.3	6.4	5.2	4.5	5.0	4.0	3.3	3.9	3.1	2.5	3.0	2.5	
38.0	5.9	6.4		6.0	4.9	4.4	4.8	3.8	3.2	3.8	2.9	2.4	2.9	2.4	1.8
40.0	5.2	5.6		5.7	4.8	4.3	4.5	3.6	3.1	3.6	2.8	2.3	2.8	2.2	1.8
44.0	3.9			4.5	4.5		4.0	3.4	3.0	3.2	2.6	2.2	2.6	2.0	1.6
48.0				3.5	3.8		3.6	3.1	2.9	2.8	2.4	2.1	2.3	1.8	1.5
52.0							3.1	2.9		2.5	2.2	2.0	2.0	1.7	1.4
56.0							2.3			2.3	2.0		1.8	1.5	1.4
60.0										2.0	1.9		1.6	1.4	1.3
64.0													1.5	1.3	
68.0													1.2		

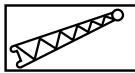
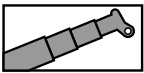

47t

DIN/ISO/EN

m	13.2 m + 13.2 m			13.2 m + 19.2 m			13.2 m + 25.2 m			13.2 m + 31.2 m			13.2 m + 37.2 m		
	0°	20°	40°	0°	20°	40°	0°	20°	40°	0°	20°	40°	0°	20°	40°
3.0	18.0														
3.5	18.0			16.0											
4.0	18.0			15.7			10.4								
4.5	17.4			15.4			10.4								
5.0	16.7			15.0			10.4			6.4					
6.0	15.4			14.3			10.4			6.4			4.6		
7.0	14.4	11.5		13.6			10.4			6.4			4.6		
8.0	13.4	10.9		13.0			10.4			6.4			4.6		
9.0	12.6	10.3		12.4			10.0			6.4			4.6		
10.0	11.9	9.8		11.7			9.5			6.4			4.6		
11.0	11.2	9.4		11.1	9.0		9.0			6.4			4.6		
12.0	10.6	9.0	7.9	10.5	8.6		8.6			6.4			4.6		
14.0	9.6	8.3	7.4	9.5	7.9		7.8			6.3			4.6		
16.0	8.8	7.8	7.1	8.7	7.1	5.9	7.1	6.0		5.8			4.5		
18.0	8.1	7.3	6.8	7.8	6.5	5.5	6.5	5.6		5.4			4.2		
20.0	7.5	6.9	6.7	7.0	5.9	5.2	6.0	5.0		5.0			4.0		
22.0	7.1	6.7		6.3	5.5	4.9	5.5	4.6		4.6	3.9		3.7		
24.0				5.7	5.1	4.6	4.9	4.2		4.3	3.6		3.5	3.1	
26.0				5.2	4.7	4.4	4.5	3.9	3.5	3.8	3.3		3.3	2.9	
28.0				4.7	4.5		4.1	3.6	3.3	3.5	3.0		3.1	2.6	
30.0							3.7	3.4	3.1	3.2	2.8		2.8	2.4	
32.0							3.4	3.2	3.0	2.9	2.6	2.4	2.5	2.2	
34.0							3.2	3.0		2.7	2.4	2.2	2.3	2.1	
36.0							2.9			2.5	2.3	2.1	2.1	1.9	1.7
38.0										2.3	2.2	2.0	2.0	1.8	1.6
40.0										2.1	2.0		1.8	1.7	1.5
44.0													1.5	1.5	1.4
48.0													1.3	1.3	

Hubhöhen
Lifting heights
Hauteurs de levage
Alturas de elevación

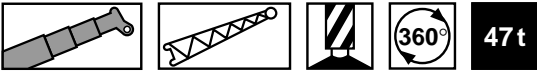

DIN/ISO/EN

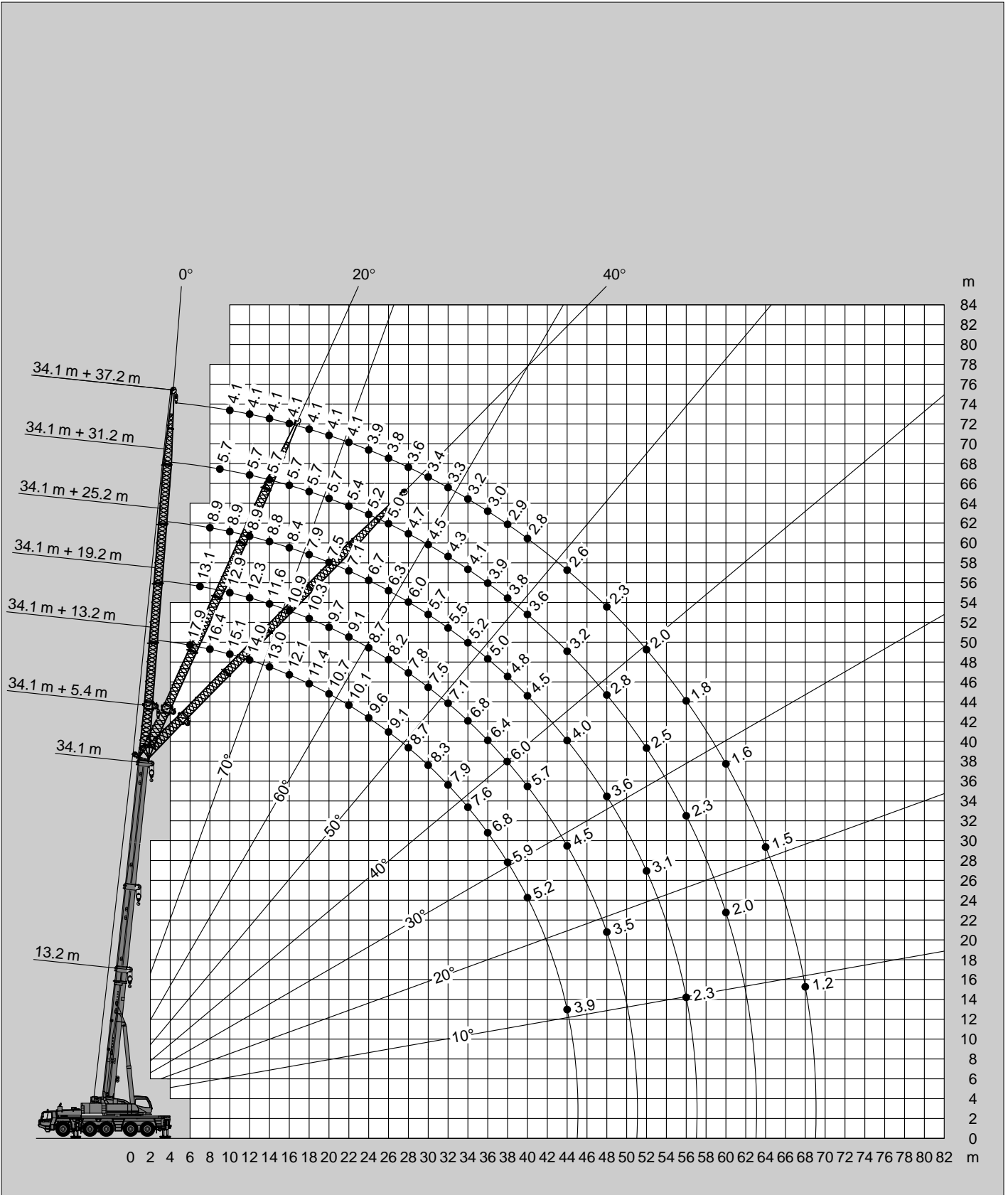

Tragfähigkeiten
Lifting capacities
Capacités de levage
Capacidades de elevación

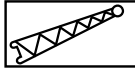
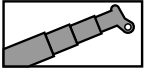

35t

DIN/ISO/EN

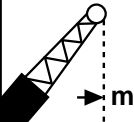
	13.2 m + 5.4 m			34.1 m + 5.4 m			63.4 m + 5.4 m			68.0 m + 5.4 m		
	0°	20°	40°	0°	20°	40°	0°	20°	40°	0°	20°	40°
3.0	47.5											
3.5	45.0	30.4										
4.0	42.6	29.4										
4.5	40.6	28.5										
5.0	38.7	27.6	22.2									
6.0	35.5	26.1	21.4	38.7								
7.0	32.8	24.8	20.7	38.7								
8.0	30.5	23.7	20.1	38.7	28.5							
9.0	28.5	22.7	19.6	38.7	27.7	21.5						
10.0	26.8	21.8	19.3	38.4	27.0	21.2						
11.0	25.2	21.1	18.7	36.4	26.3	20.9						
12.0	23.7	20.1	18.3	34.5	25.6	20.6						
14.0	20.7	18.5		29.2	24.5	20.1	10.9			9.2		
16.0	18.1			23.3	23.5	19.6	10.3	9.6	9.2	9.2	8.8	
18.0				18.8	19.6	19.2	9.8	9.1	8.8	8.9	8.4	8.1
20.0				15.3	16.1	16.6	9.3	8.7	8.4	8.5	8.0	7.7
22.0				12.6	13.3	13.6	8.9	8.3	8.1	8.1	7.7	7.4
24.0				10.5	11.0	11.3	8.5	8.0	7.7	7.8	7.4	7.1
26.0				8.7	9.1	9.4	8.1	7.7	7.4	7.5	7.1	6.9
28.0				7.2	7.6	7.7	7.8	7.5	7.2	7.2	6.9	6.7
30.0				6.0	6.3	6.4	7.5	7.2	7.0	6.9	6.6	6.5
32.0				4.9	5.1		6.8	7.0	6.8	6.6	6.4	6.3
34.0				4.0	4.1		5.8	6.1	6.4	6.0	6.2	6.1
36.0				3.2			5.0	5.3	5.5	5.1	5.4	5.6
38.0							4.2	4.5	4.7	4.4	4.6	4.8
40.0							3.6	3.8	3.9	3.7	4.0	4.1
44.0							2.4	2.6	2.8	2.6	2.8	2.9
48.0							1.5	1.7	1.8	1.7	1.8	1.9

Hubhöhen
Lifting heights
Hauteurs de levage
Alturas de elevación

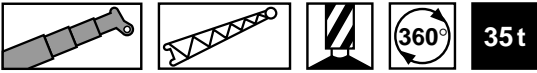

DIN/ISO/EN

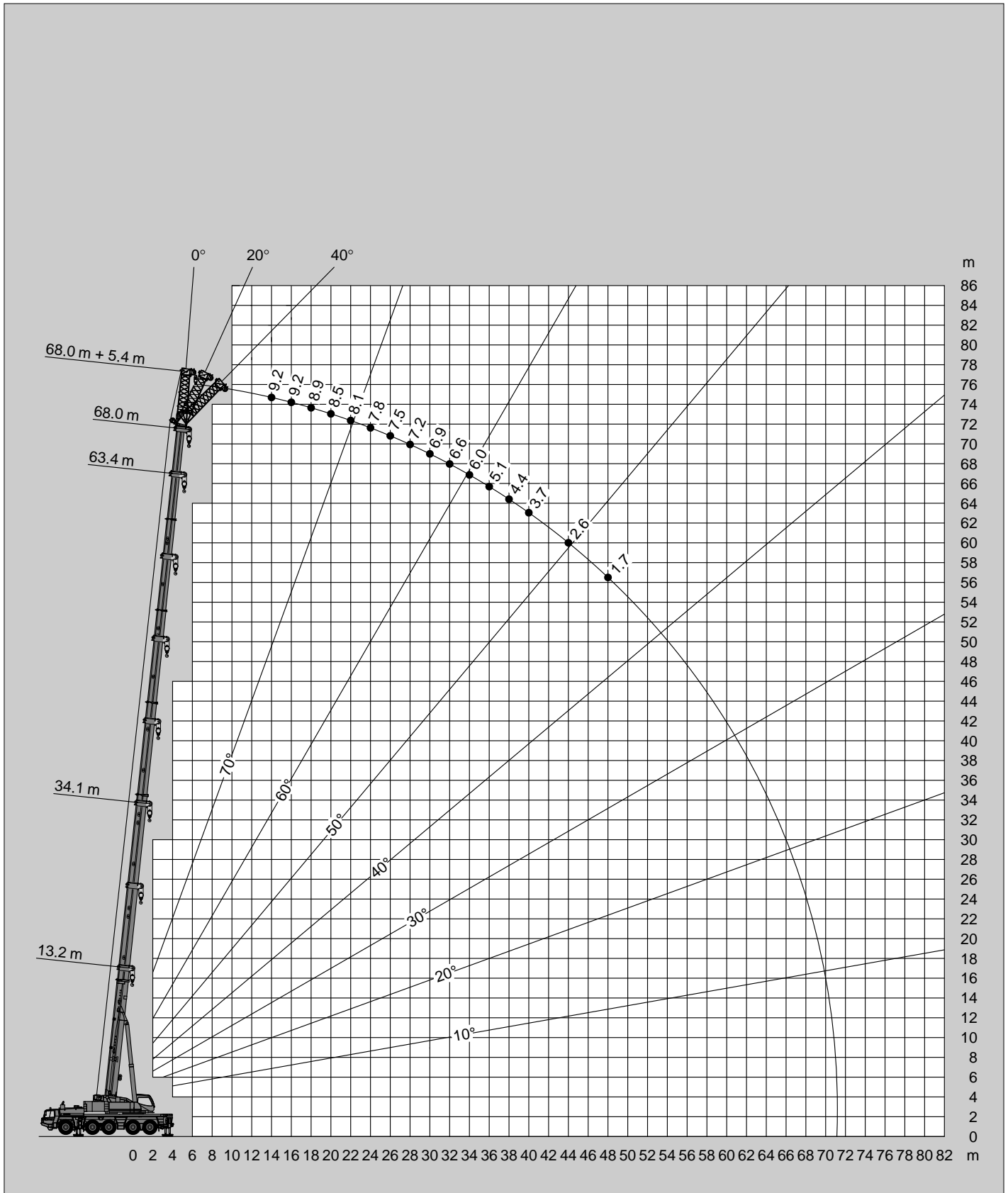

Tragfähigkeiten
Lifting capacities
Capacités de levage
Capacidades de elevación

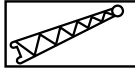
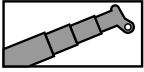

35t

DIN/ISO/EN

m	68.0 m + 13.2 m			68.0 m + 19.2 m			68.0 m + 25.2 m			68.0 m + 31.2 m			68.0 m + 37.2 m		
	0°	20°	40°	0°	20°	40°	0°	20°	40°	0°	20°	40°	0°		
14.0	5.9														
16.0	5.9			4.6											
18.0	5.9			4.6											
20.0	5.9	5.9		4.6			3.6			2.8			2.3		
22.0	5.9	5.9		4.6			3.6			2.8			2.3		
24.0	5.9	5.8	5.4	4.6	4.6		3.6			2.8			2.3		
26.0	5.9	5.6	5.2	4.6	4.6		3.6			2.8			2.3		
28.0	5.9	5.4	5.0	4.6	4.4		3.6	3.6		2.8			2.3		
30.0	5.7	5.2	4.9	4.6	4.3	3.9	3.6	3.6		2.8			2.3		
32.0	5.5	5.0	4.7	4.6	4.1	3.8	3.6	3.4		2.8			2.3		
34.0	5.3	4.8	4.6	4.5	4.0	3.7	3.6	3.3		2.8	2.7		2.3		
36.0	5.2	4.7	4.5	4.3	3.9	3.6	3.6	3.2	3.0	2.8	2.6		2.3		
38.0	4.9	4.5	4.3	4.2	3.8	3.5	3.5	3.1	2.9	2.8	2.6		2.3		
40.0	4.3	4.4	4.2	4.0	3.6	3.4	3.4	3.0	2.8	2.8	2.5		2.3		
44.0	3.1	3.7	4.0	3.5	3.4	3.2	3.2	2.8	2.6	2.7	2.3	2.1	2.2		
48.0	2.2	2.7	3.1	2.5	3.2	3.1	2.6	2.7	2.5	2.5	2.2	2.0	2.1		
52.0	1.4	1.9	2.2	1.7	2.4	2.9	1.8	2.5	2.4	1.9	2.0	1.9	1.9		
56.0			1.4		1.6	2.0	1.2	1.9	2.3	1.2	1.9	1.8	1.3		
60.0						1.3		1.3	1.8		1.5	1.7			
64.0											1.5				

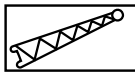
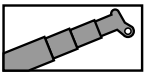

35t

DIN/ISO/EN

m	63.4 m + 13.2 m			63.4 m + 19.2 m			63.4 m + 25.2 m			63.4 m + 31.2 m			63.4 m + 37.2 m		
	0°	20°	40°	0°	20°	40°	0°	20°	40°	0°	20°	40°	0°	20°	
14.0	6.8			5.2											
16.0	6.8			5.2			4.0			3.2					
18.0	6.8			5.2			4.0			3.2				2.5	
20.0	6.8	6.7		5.2			4.0			3.2				2.5	
22.0	6.8	6.4		5.2	5.2		4.0			3.2				2.5	
24.0	6.8	6.2	5.7	5.2	5.1		4.0			3.2				2.5	
26.0	6.7	6.0	5.5	5.2	4.9		4.0	4.0		3.2				2.5	
28.0	6.4	5.8	5.4	5.2	4.7		4.0	3.9		3.2				2.5	
30.0	6.2	5.6	5.2	5.2	4.5	4.2	4.0	3.8		3.2	3.0			2.5	
32.0	5.9	5.4	5.0	5.0	4.4	4.1	4.0	3.6		3.2	3.0			2.5	
34.0	5.7	5.2	4.9	4.8	4.3	3.9	4.0	3.5	3.2	3.2	2.9			2.5	2.1
36.0	5.5	5.0	4.8	4.6	4.1	3.8	3.9	3.4	3.1	3.2	2.8			2.5	2.1
38.0	5.1	4.9	4.6	4.5	4.0	3.7	3.8	3.3	3.0	3.2	2.7			2.4	2.0
40.0	4.4	4.7	4.5	4.3	3.9	3.6	3.7	3.2	3.0	3.1	2.6	2.4		2.4	2.0
44.0	3.2	3.8	4.2	3.4	3.7	3.4	3.4	3.0	2.8	2.8	2.4	2.3		2.3	1.9
48.0	2.3	2.8	3.1	2.5	3.2	3.3	2.8	2.8	2.7	2.7	2.3	2.1		2.2	1.8
52.0	1.5	1.9	2.2	1.7	2.3	2.8	2.0	2.7	2.5	2.0	2.2	2.0		2.1	1.7
56.0		1.2	1.4		1.6	1.9	1.3	2.0	2.4	1.4	2.0	1.9		1.4	1.6
60.0						1.2		1.4	1.8		1.6	1.8			1.5
64.0												1.5			1.2

Hubhöhen
Lifting heights
Hauteurs de levage
Alturas de elevación

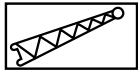
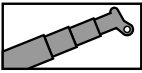

35t

DIN/ISO/EN

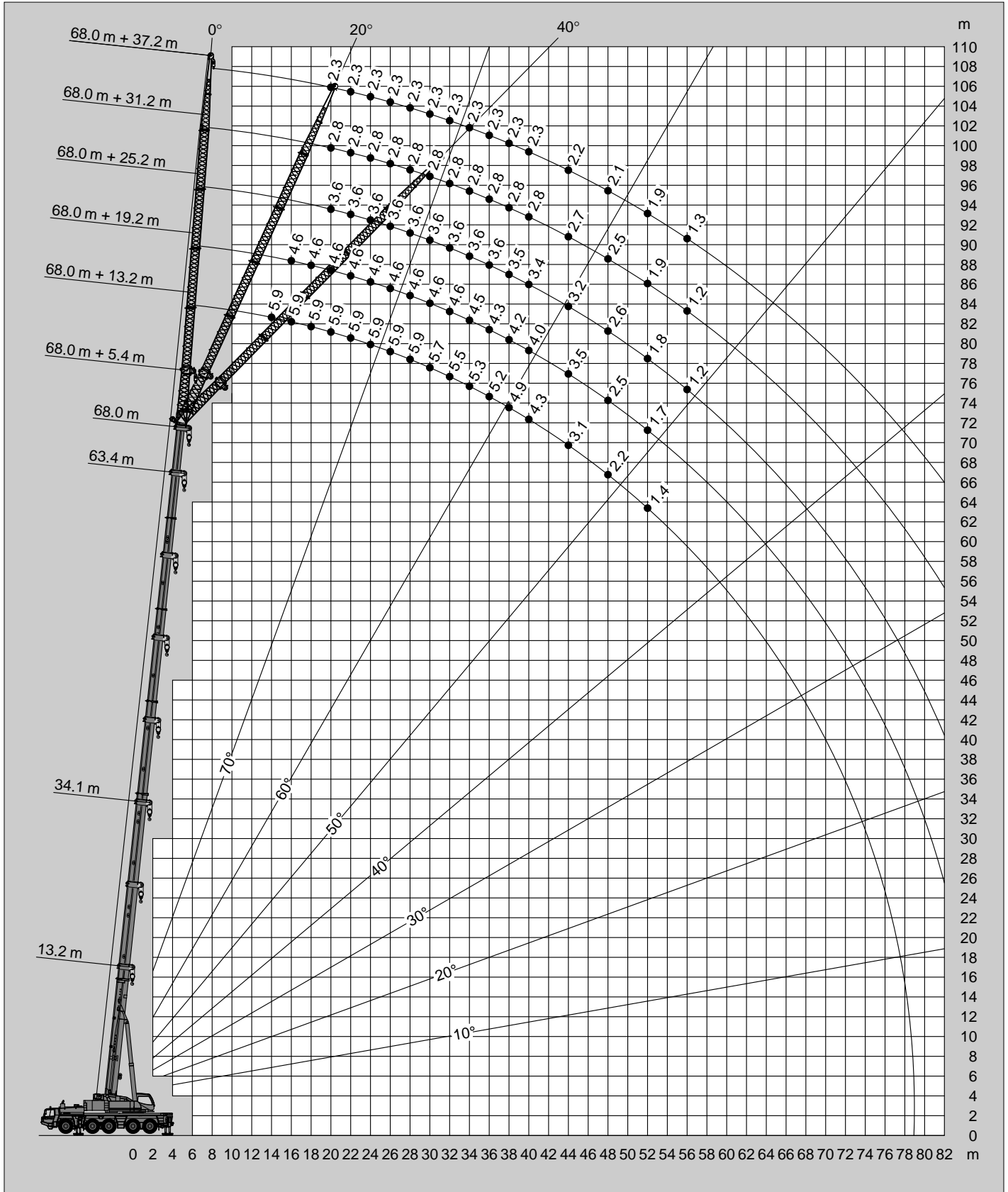

Tragfähigkeiten
Lifting capacities
Capacités de levage
Capacidades de elevación

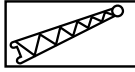
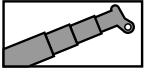

35t

DIN/ISO/EN

m	34.1 m + 13.2 m			34.1 m + 19.2 m			34.1 m + 25.2 m			34.1 m + 31.2 m			34.1 m + 37.2 m		
	0°	20°	40°	0°	20°	40°	0°	20°	40°	0°	20°	40°	0°	20°	40°
6.0	17.9														
7.0	17.2			13.1											
8.0	16.4			13.1			8.9								
9.0	15.8			13.1			8.9			5.7					
10.0	15.1			12.9			8.9			5.7			4.1		
11.0	14.5	10.4		12.6			8.9			5.7			4.1		
12.0	14.0	10.2		12.3			8.9			5.7			4.1		
14.0	13.0	9.6		11.6			8.8			5.7			4.1		
16.0	12.1	9.1	7.6	10.9	8.2		8.4			5.7			4.1		
18.0	11.4	8.7	7.3	10.3	7.8		7.9			5.7			4.1		
20.0	10.7	8.3	7.1	9.7	7.4	5.8	7.5	5.7		5.7			4.1		
22.0	10.1	8.0	6.9	9.1	7.1	5.6	7.1	5.4		5.4			4.1		
24.0	9.6	7.7	6.8	8.7	6.8	5.4	6.7	5.2		5.2	4.1		3.9		
26.0	9.1	7.5	6.6	8.2	6.5	5.2	6.3	5.0		5.0	3.9		3.8		
28.0	8.7	7.2	6.5	7.8	6.2	5.0	6.0	4.8	3.8	4.7	3.7		3.6		
30.0	7.5	7.0	6.4	7.5	5.9	4.9	5.7	4.6	3.7	4.5	3.6		3.4	2.8	
32.0	6.4	6.8	6.3	7.0	5.6	4.7	5.5	4.4	3.5	4.3	3.4	2.7	3.3	2.7	
34.0	5.4	6.1	6.3	6.1	5.4	4.6	5.2	4.2	3.4	4.1	3.3	2.6	3.2	2.6	
36.0	4.6	5.2	5.6	5.2	5.2	4.5	5.0	4.0	3.3	3.9	3.1	2.5	3.0	2.5	
38.0	3.8	4.4		4.5	4.9	4.4	4.8	3.8	3.2	3.8	2.9	2.4	2.9	2.4	1.8
40.0	3.2	3.6		3.8	4.6	4.3	4.4	3.6	3.1	3.6	2.8	2.3	2.8	2.2	1.8
44.0	2.1			2.7	3.3		3.3	3.4	3.0	3.2	2.6	2.2	2.6	2.0	1.6
48.0				1.8	2.2		2.4	3.0	2.9	2.7	2.4	2.1	2.3	1.8	1.5
52.0							1.6	2.0		1.9	2.2	2.0	2.0	1.7	1.4
56.0										1.2	1.8		1.5	1.5	1.4
60.0													1.4	1.4	1.3

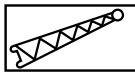
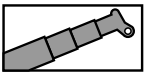

35t

DIN/ISO/EN

m	13.2 m + 13.2 m			13.2 m + 19.2 m			13.2 m + 25.2 m			13.2 m + 31.2 m			13.2 m + 37.2 m		
	0°	20°	40°	0°	20°	40°	0°	20°	40°	0°	20°	40°	0°	20°	40°
3.0	18.0														
3.5	18.0			16.0											
4.0	18.0			15.7			10.4								
4.5	17.4			15.4			10.4								
5.0	16.7			15.0			10.4			6.4					
6.0	15.4			14.3			10.4			6.4			4.6		
7.0	14.4	11.5		13.6			10.4			6.4			4.6		
8.0	13.4	10.9		13.0			10.4			6.4			4.6		
9.0	12.6	10.3		12.4			10.0			6.4			4.6		
10.0	11.9	9.8		11.7			9.5			6.4			4.6		
11.0	11.2	9.4		11.1	9.0		9.0			6.4			4.6		
12.0	10.6	9.0	7.9	10.5	8.6		8.6			6.4			4.6		
14.0	9.6	8.3	7.4	9.5	7.9		7.8			6.3			4.6		
16.0	8.8	7.8	7.1	8.7	7.1	5.9	7.1	6.0		5.8			4.5		
18.0	8.1	7.3	6.8	7.8	6.5	5.5	6.5	5.6		5.4			4.2		
20.0	7.5	6.9	6.7	7.0	5.9	5.2	6.0	5.0		5.0			4.0		
22.0	7.1	6.7		6.3	5.5	4.9	5.5	4.6		4.6	3.9		3.7		
24.0				5.7	5.1	4.6	4.9	4.2		4.3	3.6		3.5	3.1	
26.0				5.2	4.7	4.4	4.5	3.9	3.5	3.8	3.3		3.3	2.9	
28.0				4.7	4.5		4.1	3.6	3.3	3.5	3.0		3.1	2.6	
30.0							3.7	3.4	3.1	3.2	2.8		2.8	2.4	
32.0							3.4	3.2	3.0	2.9	2.6	2.4	2.5	2.2	
34.0							3.2	3.0		2.7	2.4	2.2	2.3	2.1	
36.0							2.9			2.5	2.3	2.1	2.1	1.9	1.7
38.0										2.3	2.2	2.0	2.0	1.8	1.6
40.0										2.1	2.0		1.8	1.7	1.5
44.0													1.5	1.5	1.4
48.0													1.3	1.3	

Hubhöhen
Lifting heights
Hauteurs de levage
Alturas de elevación

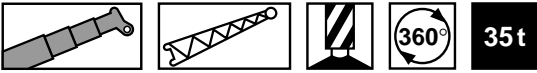

DIN/ISO/EN

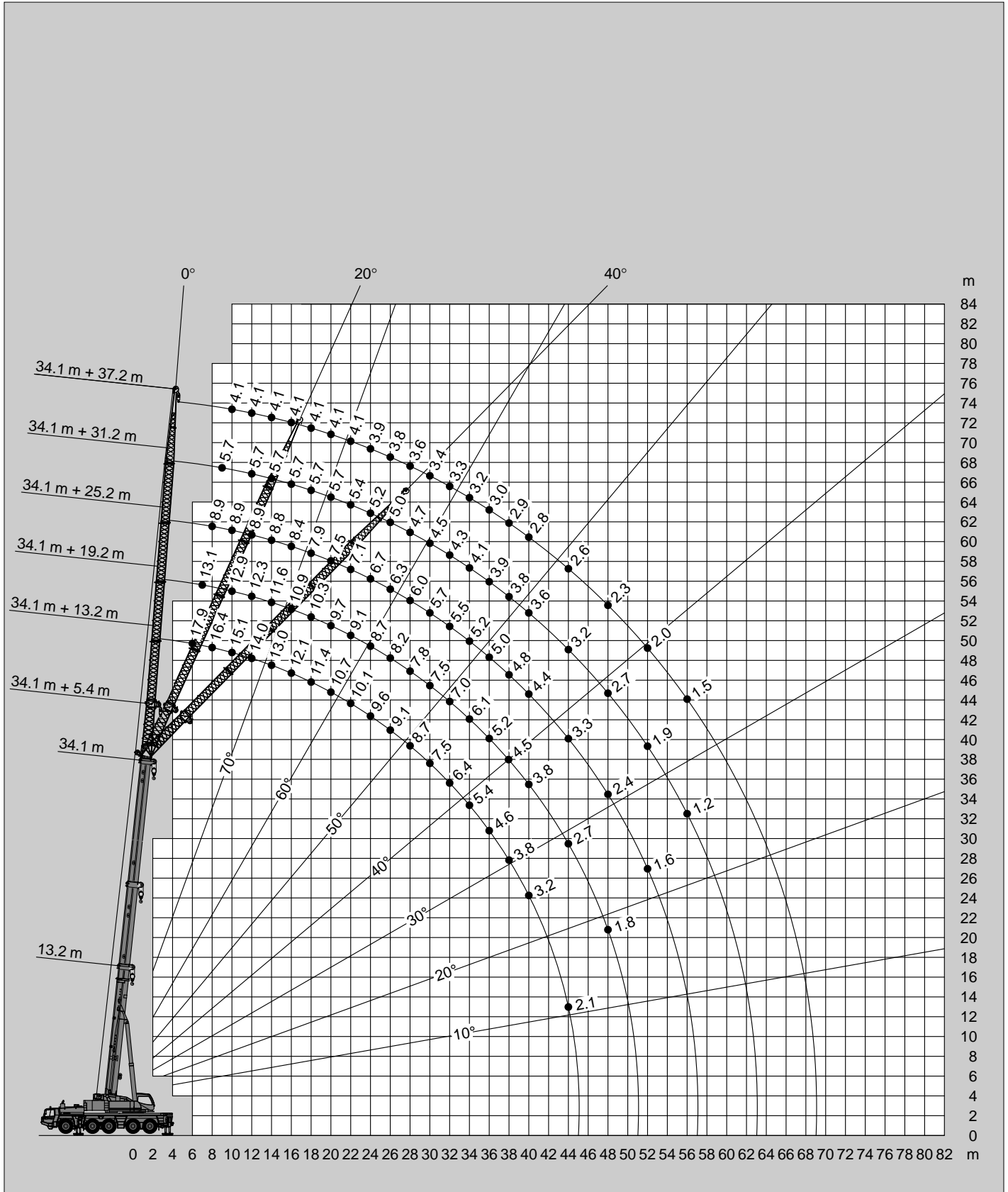

Tragfähigkeiten
Lifting capacities
Capacités de levage
Capacidades de elevación

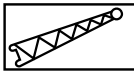
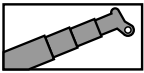

23.5t

DIN/ISO/EN

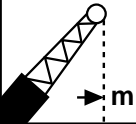
	13.2 m + 5.4 m			34.1 m + 5.4 m			63.4 m + 5.4 m			68.0 m + 5.4 m		
	0°	20°	40°	0°	20°	40°	0°	20°	40°	0°	20°	40°
3.0	47.5											
3.5	45.0	30.4										
4.0	42.6	29.4										
4.5	40.6	28.5										
5.0	38.7	27.6	22.2									
6.0	35.5	26.1	21.4	38.7								
7.0	32.8	24.8	20.7	38.7								
8.0	30.5	23.7	20.1	38.7	28.5							
9.0	28.5	22.7	19.6	38.7	27.7	21.5						
10.0	26.8	21.8	19.3	36.8	27.0	21.2						
11.0	25.2	21.1	18.7	32.3	26.3	20.9						
12.0	23.7	20.1	18.3	28.7	25.6	20.6						
14.0	20.7	18.5		22.9	24.1	20.1	10.9			9.2		
16.0	18.1			17.9	19.0	19.6	10.3	9.6	9.2	9.2	8.8	
18.0				14.1	15.0	15.6	9.8	9.1	8.8	8.9	8.4	8.1
20.0				11.1	11.8	12.3	9.3	8.7	8.4	8.5	8.0	7.7
22.0				8.8	9.4	9.8	8.9	8.3	8.1	8.1	7.7	7.4
24.0				6.9	7.4	7.8	8.5	8.0	7.7	7.8	7.4	7.1
26.0				5.4	5.9	6.1	7.5	7.7	7.4	7.5	7.1	6.9
28.0				4.2	4.5	4.7	6.2	6.6	6.9	6.4	6.8	6.7
30.0				3.1	3.4	3.5	5.1	5.5	5.7	5.3	5.7	6.0
32.0				2.2	2.5		4.2	4.5	4.7	4.3	4.7	4.9
34.0				1.5	1.6		3.4	3.7	3.9	3.5	3.8	4.1
36.0							2.7	2.9	3.1	2.8	3.1	3.3
38.0							2.0	2.3	2.5	2.2	2.5	2.7
40.0							1.5	1.7	1.9	1.6	1.9	2.1

Hubhöhen
Lifting heights
Hauteurs de levage
Alturas de elevación

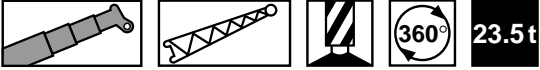

DIN/ISO/EN

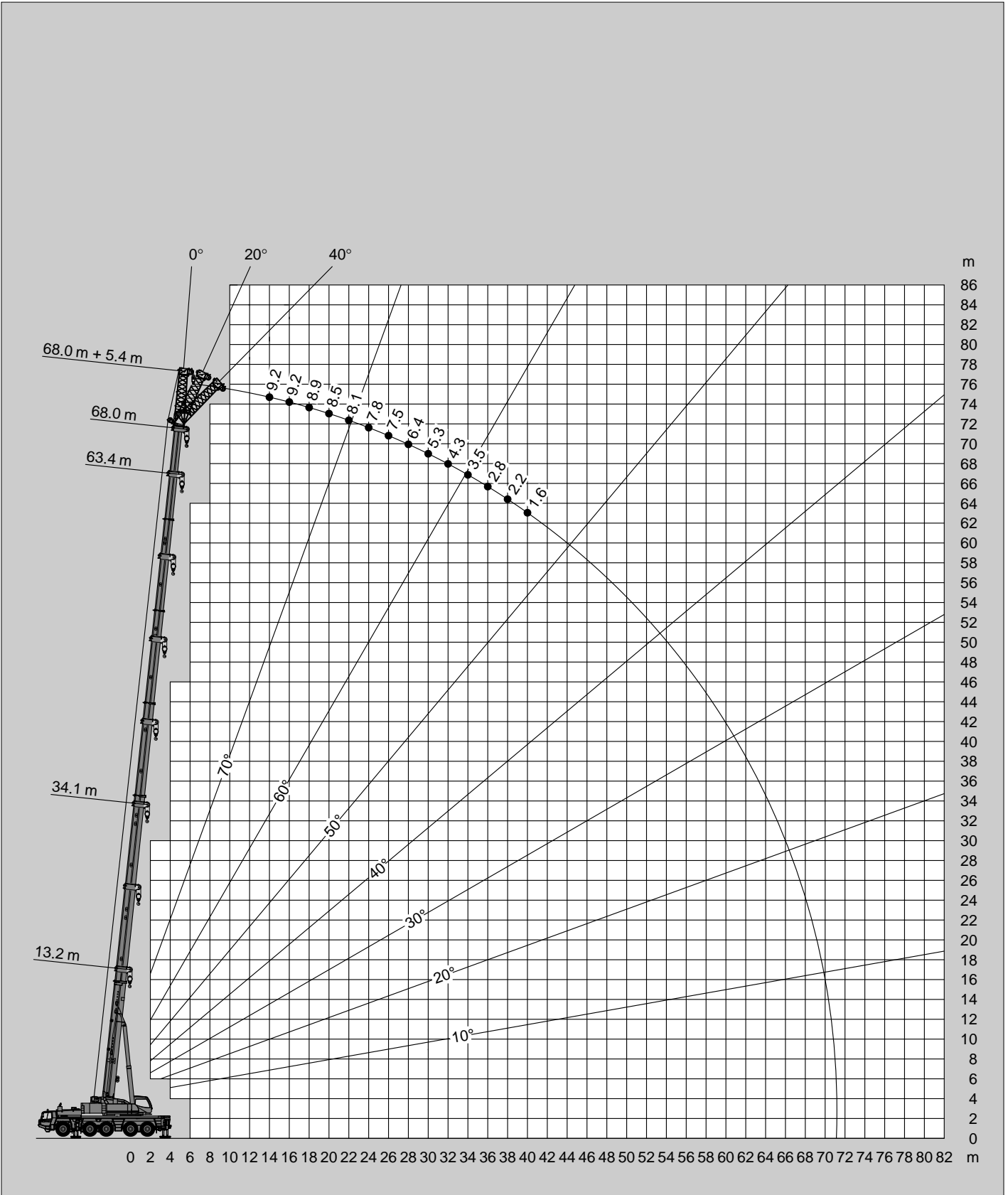

Tragfähigkeiten
Lifting capacities
Capacités de levage
Capacidades de elevación

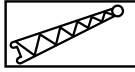
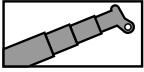

23.5t

DIN/ISO/EN

	68.0 m + 13.2 m			68.0 m + 19.2 m			68.0 m + 25.2 m			68.0 m + 31.2 m			68.0 m + 37.2 m		
	0°	20°	40°	0°	20°	40°	0°	20°	40°	0°			0°		
14.0	5.9														
16.0	5.9			4.6											
18.0	5.9			4.6											
20.0	5.9	5.9		4.6			3.6			2.8			2.3		
22.0	5.9	5.9		4.6			3.6			2.8			2.3		
24.0	5.9	5.8	5.4	4.6	4.6		3.6			2.8			2.3		
26.0	5.9	5.6	5.2	4.6	4.6		3.6			2.8			2.3		
28.0	5.9	5.4	5.0	4.6	4.4		3.6	3.6		2.8			2.3		
30.0	5.7	5.2	4.9	4.6	4.3	3.9	3.6	3.6		2.8			2.3		
32.0	4.9	5.0	4.7	4.6	4.1	3.8	3.6	3.4		2.8			2.3		
34.0	4.1	4.8	4.6	4.5	4.0	3.7	3.6	3.3		2.8			2.3		
36.0	3.4	4.2	4.5	3.8	3.9	3.6	3.6	3.2	3.0	2.8			2.3		
38.0	2.8	3.5	4.1	3.1	3.8	3.5	3.3	3.1	2.9	2.8			2.3		
40.0	2.2	2.9	3.4	2.6	3.5	3.4	2.7	3.0	2.8	2.7			2.3		
44.0	1.3	1.9	2.3	1.6	2.5	3.1	1.7	2.8	2.6	1.8			1.9		
48.0			1.4		1.6	2.1		1.9	2.5						
52.0						1.3		1.2	1.8						

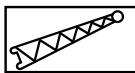
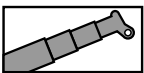

23.5t

DIN/ISO/EN

	63.4 m + 13.2 m			63.4 m + 19.2 m			63.4 m + 25.2 m			63.4 m + 31.2 m			63.4 m + 37.2 m		
	0°	20°	40°	0°	20°	40°	0°	20°	40°	0°	20°		0°		
14.0	6.8			5.2											
16.0	6.8			5.2			4.0			3.2					
18.0	6.8			5.2			4.0			3.2				2.5	
20.0	6.8	6.7		5.2			4.0			3.2				2.5	
22.0	6.8	6.4		5.2	5.2		4.0			3.2				2.5	
24.0	6.8	6.2	5.7	5.2	5.1		4.0			3.2				2.5	
26.0	6.7	6.0	5.5	5.2	4.9		4.0	4.0		3.2				2.5	
28.0	6.4	5.8	5.4	5.2	4.7		4.0	3.9		3.2				2.5	
30.0	6.0	5.6	5.2	5.2	4.5	4.2	4.0	3.8		3.2	3.0			2.5	
32.0	5.0	5.4	5.0	5.0	4.4	4.1	4.0	3.6		3.2	3.0			2.5	
34.0	4.2	5.0	4.9	4.4	4.3	3.9	4.0	3.5	3.2	3.2	2.9			2.5	
36.0	3.5	4.3	4.8	3.7	4.1	3.8	3.9	3.4	3.1	3.2	2.8			2.5	
38.0	2.9	3.6	4.1	3.1	4.0	3.7	3.4	3.3	3.0	3.2	2.7			2.4	
40.0	2.3	3.0	3.5	2.5	3.4	3.6	2.8	3.2	3.0	2.9	2.6			2.4	
44.0	1.4	1.9	2.4	1.6	2.4	3.0	1.9	2.9	2.8	1.9	2.4			2.0	
48.0			1.4		1.5	2.0		2.0	2.7		2.3			1.2	
52.0						1.2		1.3	1.9		1.5				
56.0									1.2						

Hubhöhen
Lifting heights
Hauteurs de levage
Alturas de elevación

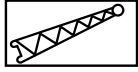
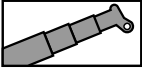

23.5t

DIN/ISO/EN

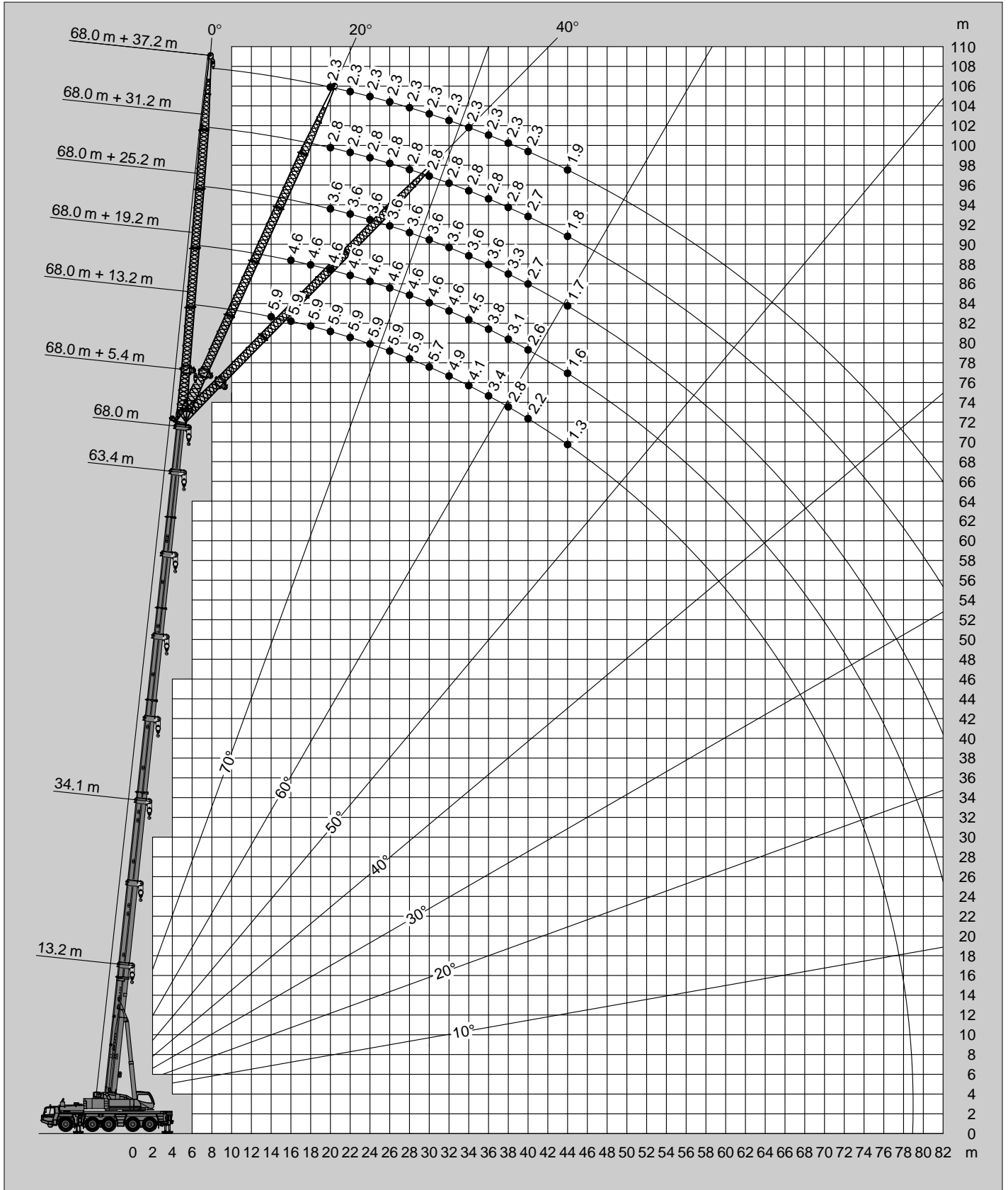

Tragfähigkeiten
Lifting capacities
Capacités de levage
Capacidades de elevación

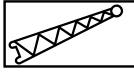
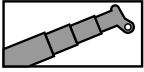

23.5t

DIN/ISO/EN

m	34.1 m + 13.2 m			34.1 m + 19.2 m			34.1 m + 25.2 m			34.1 m + 31.2 m			34.1 m + 37.2 m		
	0°	20°	40°	0°	20°	40°	0°	20°	40°	0°	20°	40°	0°	20°	40°
6.0	17.9														
7.0	17.2			13.1											
8.0	16.4			13.1			8.9								
9.0	15.8			13.1			8.9			5.7					
10.0	15.1			12.9			8.9			5.7			4.1		
11.0	14.5	10.4		12.6			8.9			5.7			4.1		
12.0	14.0	10.2		12.3			8.9			5.7			4.1		
14.0	13.0	9.6		11.6			8.8			5.7			4.1		
16.0	12.1	9.1	7.6	10.9	8.2		8.4			5.7			4.1		
18.0	11.4	8.7	7.3	10.3	7.8		7.9			5.7			4.1		
20.0	10.7	8.3	7.1	9.7	7.4	5.8	7.5	5.7		5.7			4.1		
22.0	10.1	8.0	6.9	9.1	7.1	5.6	7.1	5.4		5.4			4.1		
24.0	8.5	7.7	6.8	8.7	6.8	5.4	6.7	5.2		5.2	4.1		3.9		
26.0	7.0	7.5	6.6	7.7	6.5	5.2	6.3	5.0		5.0	3.9		3.8		
28.0	5.7	6.8	6.5	6.4	6.2	5.0	6.0	4.8	3.8	4.7	3.7		3.6		
30.0	4.6	5.6	6.3	5.4	5.9	4.9	5.7	4.6	3.7	4.5	3.6		3.4	2.8	
32.0	3.7	4.6	5.2	4.4	5.6	4.7	5.1	4.4	3.5	4.3	3.4	2.7	3.3	2.7	
34.0	2.9	3.7	4.1	3.6	4.7	4.6	4.3	4.2	3.4	4.1	3.3	2.6	3.2	2.6	
36.0	2.3	2.9	3.2	2.9	3.9	4.5	3.6	4.0	3.3	3.9	3.1	2.5	3.0	2.5	
38.0	1.7	2.2		2.3	3.2	3.8	2.9	3.8	3.2	3.3	2.9	2.4	2.9	2.4	1.8
40.0		1.5		1.8	2.5	3.1	2.4	3.5	3.1	2.7	2.8	2.3	2.8	2.2	1.8
44.0					1.4		1.4	2.3	3.0	1.8	2.6	2.2	2.1	2.0	1.6
48.0								1.3	1.8		1.9	2.1	1.3	1.8	1.5
52.0												1.6		1.6	1.4
56.0															1.4

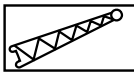
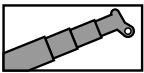

23.5t

DIN/ISO/EN

m	13.2 m + 13.2 m			13.2 m + 19.2 m			13.2 m + 25.2 m			13.2 m + 31.2 m			13.2 m + 37.2 m		
	0°	20°	40°	0°	20°	40°	0°	20°	40°	0°	20°	40°	0°	20°	40°
3.0	18.0														
3.5	18.0			16.0											
4.0	18.0			15.7			10.4								
4.5	17.4			15.4			10.4								
5.0	16.7			15.0			10.4			6.4					
6.0	15.4			14.3			10.4			6.4			4.6		
7.0	14.4	11.5		13.6			10.4			6.4			4.6		
8.0	13.4	10.9		13.0			10.4			6.4			4.6		
9.0	12.6	10.3		12.4			10.0			6.4			4.6		
10.0	11.9	9.8		11.7			9.5			6.4			4.6		
11.0	11.2	9.4		11.1	9.0		9.0			6.4			4.6		
12.0	10.6	9.0	7.9	10.5	8.6		8.6			6.4			4.6		
14.0	9.6	8.3	7.4	9.5	7.9		7.8			6.3			4.6		
16.0	8.8	7.8	7.1	8.7	7.1	5.9	7.1	6.0		5.8			4.5		
18.0	8.1	7.3	6.8	7.8	6.5	5.5	6.5	5.6		5.4			4.2		
20.0	7.5	6.9	6.7	7.0	5.9	5.2	6.0	5.0		5.0			4.0		
22.0	7.1	6.7		6.3	5.5	4.9	5.5	4.6		4.6	3.9		3.7		
24.0				5.7	5.1	4.6	4.9	4.2		4.3	3.6		3.5	3.1	
26.0				5.2	4.7	4.4	4.5	3.9	3.5	3.8	3.3		3.3	2.9	
28.0				4.7	4.5		4.1	3.6	3.3	3.5	3.0		3.1	2.6	
30.0							3.7	3.4	3.1	3.2	2.8		2.8	2.4	
32.0							3.4	3.2	3.0	2.9	2.6	2.4	2.5	2.2	
34.0							3.2	3.0		2.7	2.4	2.2	2.3	2.1	
36.0										2.5	2.3	2.1	2.1	1.9	1.7
38.0										2.3	2.2	2.0	2.0	1.8	1.6
40.0										2.1	2.0		1.8	1.7	1.5
44.0													1.5	1.5	1.4
48.0													1.3	1.3	

Hubhöhen
Lifting heights
Hauteurs de levage
Alturas de elevación

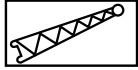
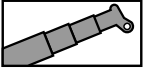

23.5t

DIN/ISO/EN

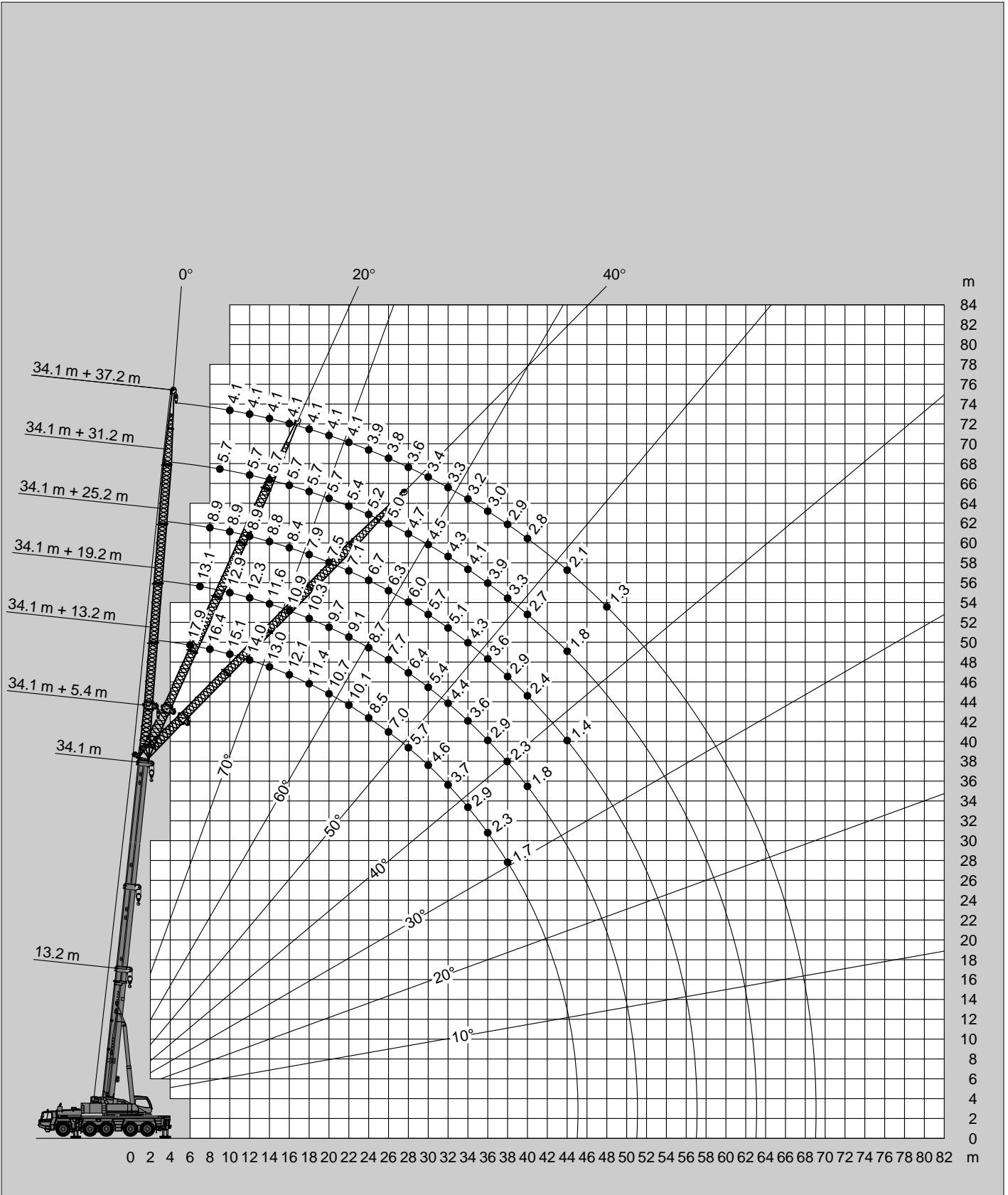

Anmerkungen zu den Traglasttabellen

Die Tragfähigkeiten im Festigkeitsbereich basieren auf DIN 15018 Blatt 2 und Blatt 3 und F.E.M.

Die Tragfähigkeiten im Standsicherheitsbereich entsprechen DIN 15019 Teil 2 / ISO 4305 / EN 13000.

Die zulässige Windgeschwindigkeit beträgt maximal 10 m/sec.

Die Tragfähigkeiten sind in metrischen Tonnen angegeben.

Das Gewicht des Lasthakens bzw. der Hakenflasche und weiterer Anschlagmittel ist von der Tragfähigkeit abzuziehen.

Die Tragfähigkeiten für den Teleskopausleger gelten nur bei demonstrierter Spitze.

Die Ausladung ist der horizontale Abstand von Mitte Drehkranz bis Mitte freihängender, nicht schwingender Last.

Tragfähigkeitsänderungen vorbehalten.

Obige Angaben dienen nur zur Information. Die Bedienungsanleitungen müssen zu Rate gezogen werden, bevor die Maschine in Betrieb genommen wird. Alle hier gemachten Angaben beziehen sich auf die Standard-Ausführung. Jegliche Ausrüstungsveränderungen können die angegebenen Werte beeinflussen.

Remarks relating to the rating charts

The lifting capacities in the structural area are based on DIN 15018 parts 2 and 3 and F.E.M.

The lifting capacities in the stability area are based on DIN 15019 part 2 / ISO 4305 / EN 13000.

The maximum permissible wind speed for crane operation is 10 m/sec.

The lifting capacities shown are in metric tons.

The weight of load handling devices such as hook blocks, slings, etc., must be considered as part of the load and must be deducted from the lifting capacities.

The lifting capacities for the telescopic boom apply to a crane with no boom extensions being stowed or mounted on the crane.

The working radius is the horizontal distance from the centre of rotation to the centre of the freely suspended non-oscillating load.

The lifting capacities are subject to change without prior notice.

The above remarks are for basic information only and the operator's manual must be consulted before operating this crane. All data and performances refer to the standard crane. The addition of optional and other equipment may affect the performance of the crane.

Remarques relatives aux tableaux des charges

Les forces de levage sont conformes aux normes DIN 15018, p. 2 et 3, et F.E.M.

Les forces de levage dans la partie de stabilité au renversement sont conformes aux normes DIN 15019, chap. 2 / ISO 4305 / EN 13000.

La grue peut travailler aux vitesses de vent allant jusqu'à 10 m/s.

Les forces de levage sont données en tonnes métriques.

Le poids du crochet-moufle et de tous les accessoires d'élingage font partie de la charge et sont à déduire des charges indiquées.

Les forces de levage indiquées pour la flèche télescopique s'entendent fléchette déposée.

Comme portée, on entend la distance horizontale du centre de la couronne de rotation au centre de la charge librement suspendue et non oscillante.

Sauf modification de forces de levage.

Les données ci-dessus servent à titre d'information. Avant la mise en marche de la grue il est conseillé d'étudier les instructions de service. Toutes les données indiquées ci-dessus se réfèrent à la machine de base. Tout changement de l'équipement de la grue peut influencer ces valeurs.

Notas relativas a los graficos de carga

En cuanto a los datos referentes a resistencia, las capacidades de carga están basados sobre las normas DIN 15018, pág. 2 y 3, y F.E.M.

En cuanto a los datos referentes a estabilidad anti-vuelco, las capacidades de carga están basados sobre las normas DIN 15019, Cap. 2 / ISO 4305 / EN 13000.

La velocidad anemométrica max. admisible es de 10 m/seg.

Las capacidades de carga indicadas en las tablas corresponden a toneladas métricas.

Hay que deducir los pesos del gancho, eslingas y de otros dispositivos para fijación de cargas de los valores indicados en las tablas.

Las capacidades de carga referentes a la pluma telescópica valen solamente si el plumín está desmontada.

Como alcance se entiende la distancia horizontal desde el centro de la corona de giro hasta el centro de la carga suspendida libremente y no oscilante.

Salvo modificación de capacidades de carga, sin previo aviso.

Los datos arriba indicados sirven solamente para su información. Hay que leer las instrucciones para el uso antes de la puesta en servicio de la máquina. Todos los datos mencionados en las presentes tablas rigen para los modelos standard. Cualquier modificación del equipo montado puede dar lugar a modificaciones de aquellos valores.

Gegengewichtvarianten
 Counterweight versions
 Variations des contrepoids
 Variaciones de contrapeso

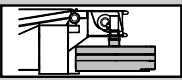
	Gegengewicht / Counterweight Contrepoids / Contrapeso	①	②	③	④	⑤	⑥	⑦
		(t)	2	10	11.5	11.5	12	12

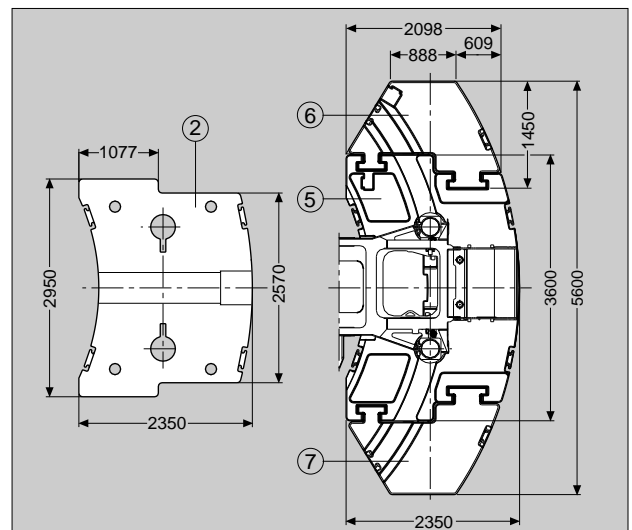
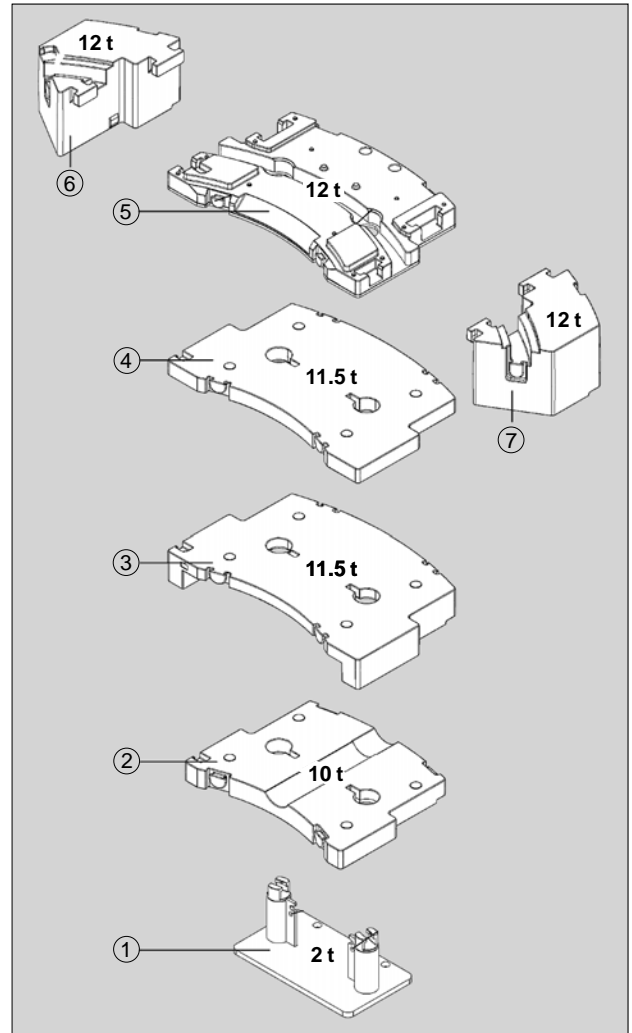
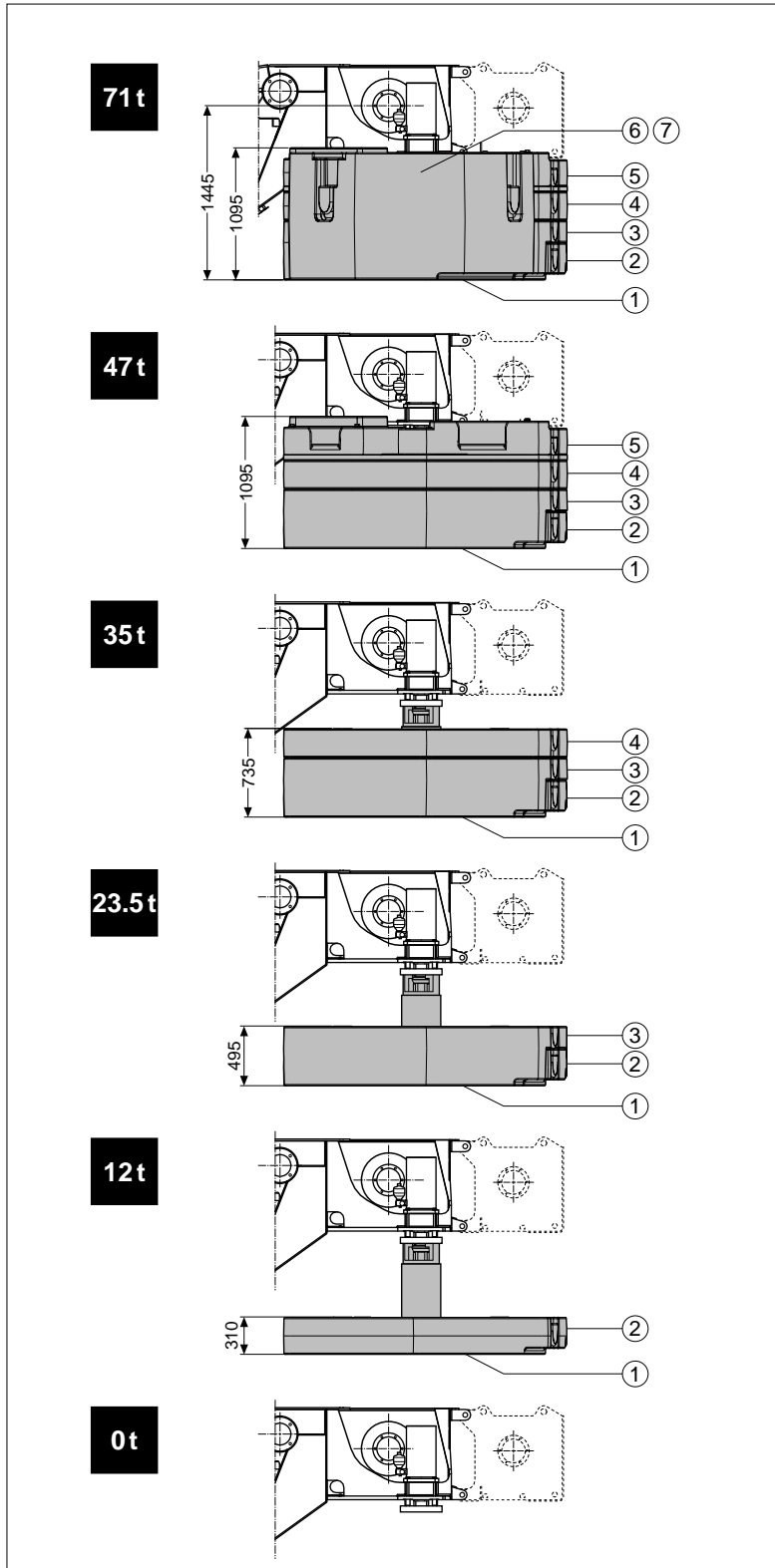

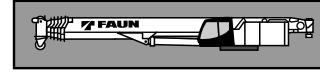

Rahmen Verwindungs- und biegesteife Schweißkonstruktion aus hochfestem Feinkornstahl. Zentralschmieranlage.

Abstützung 4-Punkt-Abstützung, hydraulisch, Bedienungsmöglichkeiten an beiden Seiten des Fahrgestelles und in der Oberwagenkabine.
Abstützbasis 8,3 m (und 5,6 m) x 9,01 m.

Motor Mercedes-Benz 8-Zylinder-Dieselmotor OM 502 LA (Euromot III A/EPA III), wassergekühlt, Leistung 390 kW (530 PS) bei 1800 min⁻¹. Drehmoment 2400 Nm (245 kpm) bei 1300 min⁻¹. Motorleistung nach 80/1269/EWG. Kraftstoffbehälter 530 l.

Getriebe ZF-AS-Tronic 16 AS 2602 mechanisches Schaltgetriebe mit elektronisch-pneumatisch betätigter Trockenkupplung und vollautomatischer Schaltung mit 16 Vorwärts- und 2 Rückwärtsgängen.

Verteilergetriebe 2-stufiges Verteilergetriebe.

Antrieb 10 x 8 (10 x 6 Optional*)

Achsen

1. Achse: gelenkt, angetrieben (*nicht angetrieben), Differentialsperre quer.
2. Achse: gelenkt, angetrieben, zuschaltbar, Differentialsperre quer.
3. Achse: nicht gelenkt, nicht angetrieben, liftbar.
4. Achse: gelenkt, angetrieben, Differentialsperre längs und quer.
5. Achse: gelenkt, angetrieben, Differentialsperre quer.

Achsaufhängung Hydropneumatische Federung mit Niveauregulierung.

Bremsen Druckluft-Zweikreis-Bremsanlage. Feststellbremse als Federspeicherbremse an der 2., 4. und 5. Achse wirkend. Intarder und Dauerbremse als Konstantdrosselanlage mit Auspuffklappenbremse.

Räder 10-fach 14.00 R 25 (385/95 R 25).

Lenkung ZF-Servocom-Zweikreis-Hydraulenlenkung mit Notlenkpumpe. Mechanische Lenkung der 1. und 2. Achse und Mitlenken der 4. Achse bis zu einer Geschwindigkeit von 25 km/h und der 5. Achse bis zu einer Fahrgeschwindigkeit von 50 km/h.

Unterswagenkabine Zwei-Mann-Frontfahrerhaus in Stahl-Kunststoff-Verbund-Konstruktion, Sicherheitsverglasung, luftgefederte Sitze und motorabhängige Warmwasserheizung, Kontroll- und Bedienungselemente für den Fahrbetrieb, Tempomat-/Bremsomat-Funktion.

Elektrische Anlage 24 Volt-Gleichstrom, 2 Batterien, Verdrahtung mit CAN-Bus-Komponenten, integrierte Eigendiagnose Faun-CSS-System, Abstützbeleuchtung. Die elektrische Anlage entspricht der EG-Norm.

Zusatzrüstung (gegen Mehrpreis)
Anhängerkupplung, motorunabhängige Zusatzheizung mit Motorvorwärmung, Klimaanlage, ABS, 16.00 R 25 (445/95 R 25), 20.5 R 25 (525/80 R 25) Bereifung, Reserverad, Sonderlackierung und Beschriftung, Stützkraftanzeige.

Weitere Zusatzrüstung auf Anfrage.

Rahmen Verwindungssteife Schweißkonstruktion mit einer außenverzahnten, einreihigen Kugeldrehverbindung, um 360° unbegrenzt drehbar. Zentralschmieranlage.

Motor Mercedes-Benz 6-Zylinder-Dieselmotor OM 906 LA (Euromot III A/EPA III), wassergekühlt. Drehzahl ist über Fußpedal stufenlos regelbar, Leistung 138 kW (188 PS) bei 1800 min⁻¹. Drehmoment 750 Nm (76 kpm) bei 1200 - 1600 min⁻¹. Motorleistung nach DIN 6270B/DIN 6271. Kraftstoffbehälter 250 l.

Hydraulik System Diesel-hydraulisch mit 3-Kreis-Hydraulik, 1 Axialkolbendoppelpumpe, 1 Axialkolbenpumpe und 1 Zahnradpumpe.

Steuerung Zwei 4-fach Kreuzsteuerhebel mit elektrischer Vorsteuerung.

Teleskopausleger Siebenteiliger Teleskopausleger aus hochfestem Feinkornstahl, bestehend aus einem Grundausleger und 6 Teleskopteilen, 1 Teleskopzylinder, hydraulisch unter Teillast teleskopierbar. 13,2 m - 68,0 m lang.

Wippwerk Ein Differentialzylinder mit angebautem Senkbremssperventil.

Hubwerk Axialkolben-Motor, Hubwerkstrommel mit eingebautem Planetengetriebe und federbelasteter Hydro-Lamellenbremse mit integriertem Freilauf beim Heben. Hubseil mit 'Super-Stop' Einrichtung.

Drehwerk Axialkolben-Motor, dreistufiges Planetengetriebe mit automatischer Feststellbremse, geschlossener Hydraulikkreislauf mit Drehwerk-Freischaltung. Drehgeschwindigkeit stufenlos von 0 - 1,2 min⁻¹.

Gegengewicht Gesamtgewicht 71 t teilbar. Die Bedienung erfolgt aus der Oberwagenkabine.

Oberwagenkabine Großräumige Krankabine in Stahl-Kunststoffausführung mit Sicherheitsverglasung mit getönten Scheiben, kippbarem Arbeitsplatz mit verstellbarem, gefedertem, gedämpftem Fahrersitz, motorabhängige und motorunabhängige Warmwasserheizung (mit Motorvorwärmung), Kontroll- und Bedienungselemente sowie graphische LCD-Anzeige für Kranbetrieb.

Elektrische Anlage 24 Volt-Gleichstrom, 2 Batterien.

Sicherheitseinrichtungen 'Lift Adjuster', Lastmomentbegrenzung (LMB), Windmesser, Arbeitsbereichsbegrenzung, Hubendschalter, Windenendschalter, Seilwindendrehmelder, Sicherheitsventile gegen Rohr- und Schlauchbrüche. Sperrventile an Hydraulik-Zylindern.

Zusatzrüstung (gegen Mehrpreis)
Auslegerverlängerungen von 13,2 m bis 37,2 m, Schwerlastspitze 5,4 m, Gegengewichtsvarianten 12 t/23,5 t/35 t/47 t, Unterflaschen von 10 t bis 160 t, Klimaanlage, 2. Hubwerk (wie Hauptwinde), Sonderlackierung und Beschriftung. Weitere Zusatzrüstung auf Anfrage.



Frame Torsion resistant, welded construction made from high strength, fine-grained steel. Central lubricating system.

Outriggers 4 point, double telescopic hydraulic outriggers with controls on both sides of carrier and in superstructure cab. Outrigger base 8.3 m (5.6 m mid extension) x 9.01 m.

Carrier engine Mercedes-Benz 8 cylinder model OM 502 LA (Euromot III A/EPA III), water-cooled diesel engine. Rated at 390 kW (530 HP) at 1800 min⁻¹. Torque 2400 Nm (245 kpm) at 1300 min⁻¹. Engine rating according to 80/1269/EWG. Fuel tank 530 l.

Transmission ZF-AS-Tronic 16 AS 2602 mechanical transmission with electro-pneumatically operated dry-type clutch and automatic gear shifting with 16 forward gears and 2 reverse gears.

Transfer Case Two stage.

Drive 10 x 8 (10 x 6 optional*)

Axles

1st axle: steered, driven (*not driven).
 2nd axle: steered, driven.
 3rd axle: not steered, not driven, lift axle.
 4th axle: steered, driven, with longitudinal differential lock.
 5th axle: steered, driven.
 All driven axles with transverse differential locks.

Suspension Hydro-pneumatic with levelling adjustment.

Brake system Service brakes: dual circuit compressed air system. Parking brake: spring loaded type acting on 2nd, 4th and 5th axles. Auxiliary brakes: intarder, engine exhaust brake and constant throttle engine brake system.

Tyres (10) 14.00 R 25 (385/95 R 25).

Steering system ZF-Servocom, dual circuit hydraulic steering with emergency steering pump, mechanical hydraulically-assisted steering of front two axles and automatic steering of the 4th axle up to a travel speed of 25 km/h and of the 5th axle up to 50 km/h.

Carrier cab Two man full width cab of composite (steel sheet metal and fibre-glass) structure, with safety glass, air-cushioned adjustable seats, engine dependent hot-water heater. Complete controls and instrumentation for road travel. Speed and brake control.

Electrical system 24 volt DC system, 2 batteries, CAN-Bus system with Faun CSS integrated self-diagnosis system, outrigger lighting. Electrical system conforms with EEC regulations.

Optional Equipment (at extra charge)

Towing attachment, engine independent additional heater with engine pre-heat, air conditioning, ABS, 16.00 R 25 (445/95 R 25), 20.5 R 25 (525/80 R 25) tyres, spare wheel and tyre, special painting and lettering, outrigger load display. Further optional equipment available upon request.

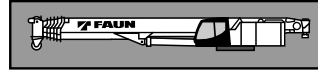

Frame Torsion-resistant, all-welded structure of high strength steel. Connected to carrier by single-row ball-bearing slewing ring with external gearing for 360° continuous rotation. Central lubricating system.

Superstructure engine Mercedes-Benz 6 cylinder model OM 906 LA (Euromot III A/EPA III), water cooled, diesel engine. Rated at 138 kW (188 HP) at 1800 min⁻¹. Torque 750 Nm (76 kpm) at 1200 - 1600 min⁻¹. Engine rating according to DIN 6270B/DIN 6271. Fuel tank 250 l.

Hydraulic system Three circuit diesel hydraulic system with 1 double axial piston pump, 1 axial piston pump and 1 gear pump.

Controls Electrical, 2 joy-stick levers for simultaneous operation of crane motions.

Telescopic boom 7 sections, made of high tensile, fine-grained steel, consisting of 1 base section and 6 telescoping sections extended by means of a single telescopic cylinder. All telescope sections extendable under partial load. 13.2 m to 68.0 m long.

Derricking system 1 double acting hydraulic cylinder with integral brake and holding valve.

Main winch Axial piston motor, winch drum with integrated planetary reduction and with hydraulically controlled spring-loaded, multiple disc brake and with integrated free rotation (no sagging of load when hoisting). Hoist cable with 'Super-Stop' easy reeving system.

Slewing system Axial piston motor with three-stage planetary reduction with a foot actuated or automatic service and a parking brake, closed hydraulic circuit with free slewing function. Speed infinitely variable 0 - 1.2 min⁻¹.

Counterweight Total 71 t divisible, assembled and disassembled by hydraulic cylinders controlled from superstructure cab.

Superstructure cab Spacious all-steel panoramic cab with safety (tinted) glass windows, tiltable cockpit with hydraulically cushioned adjustable seat, one engine dependent hot water heater and one engine independent hot-water heater (with engine pre-heat). Complete controls and instrumentation plus LCD graphic display for crane operation.

Electrical system 24 volt DC system, 2 batteries.

Safety devices 'Lift Adjuster', load moment device (LMD), anemometer, working area limiter, hoist limit switch, lower limit switch and drum turn indicator, safety valves against pipe and hose rupture, holding valves on hydraulic cylinders.

Optional Equipment (at extra charge)

Boom extensions 13.2 m to 37.2 m, heavy duty jib 5.4 m, counterweight variations 12 t/23.5 t/35 t/47 t, selection of hook blocks 10 t - 160 t, air conditioning, auxiliary winch (same as main winch), special painting and lettering. Further optional equipment available upon request.

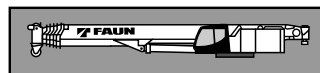
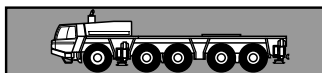

Châssis Construction mécano-soudée, en acier fin, résistante aux flexions et aux torsions. Système de graissage centralisé.

Calage Calage à 4 points, complètement hydraulique. Commande des stabilisateurs des deux côtés du châssis et de la cabine du grutier. Calage 8,3 m (aussi 5,6 m) x 9,01 m.

Moteur Mercedes Benz diesel 8 cylindres, modèle OM 502 LA (Euromot III A/EPA III), refroidi par eau, de 390 kW (530 CV) à 1800 min⁻¹.
Couple: 2400 Nm (245 kpm) à 1300 min⁻¹.
Puissance selon 80/1269/EWG.
Dépôt de combustible 530 l.

Boîte de vitesse Boîte mécanique ZF-AS-Tronic, modèle 16 AS 2602 avec embrayage électro-pneumatique réglé à commande et boîte automatique, 16 vitesses AV et 2 vitesses AR.

Boîte de transfert Boîte de transfert.

Entraînement 10 x 8 (10 x 6 optionnel*)

Essieux

- 1^{er} essieu: directeur, entraîné, (*non entraîné) blocage de différentiel transversal.
- 2^{ème} essieu: directeur, entraîné, netraîné sur commande, blocage de différentiel transversal.
- 3^{ème} essieu: non directeur, non entraîné, peut être levé.
- 4^{ème} essieu: directeur, entraîné, blocage de différentiel longitudinal et transversal.
- 5^{ème} essieu: directeur, entraîné, blocage de différentiel transversal.

Suspension Hydro-pneumatique, avec réglage de niveau.

Freins Système à air comprimé, à double circuit. Frein de stationnement: avec accumulateurs à ressort agissant sur le 2^{ème}, 4^{ème} et 5^{ème} essieu. Intarder, frein continu: Frein sur échappement avec étrangleur.

Pneus 10 x 14.00 R 25 (385/95 R 25).

Direction Servocom à double circuit, marque ZF avec pompe de direction auxiliaire. Direction mécanique du 1^{er} et 2^{ème} essieu, à assistance hydraulique, avec pompe de direction auxiliaire direction du 4^{ème} essieu jusqu'à une vitesse de 25 km/h et du 5^{ème} essieu jusqu'à une vitesse de 50 km/h.

Cabine Cabine bi-place, construction en matière composite fibre de verre et acier. Vitrage en verre de sécurité, sièges à suspension pneumatique. Chauffage à eau chaude relié au moteur. Organes de contrôle et de commande pour la conduite. Régulateur de vitesse, système automatique de freinage.

Système électrique 24 V courant continu, 2 batteries, connexion circuit électrique avec CAN-Bus. Équipement avec prise diagnostic et avec interprétation de code erreur de système FAUN CSS, illumination des calages. Conforme aux normes CE.

Équipement supplémentaire (avec supplément de prix) Attache-remorque, chauffage auxiliaire indépendant du moteur avec préchauffage du moteur, climatisation, ABS, pneus 16.00 R 25 (445/95 R 25), 20.5 R 25 (525/80 R 25), roue de secours, peinture spéciale et inscription. Indicateur de pression sur les calages.

Autres équipements supplémentaires sur demande.

Plate forme Construction mécano-soudée résistante à la torsion. Couronne d'orientation à billes à une rangée, à denture extérieure, permettant une rotation illimitée sur 360°. Système de graissage centralisé.

Moteur Mercedes Benz diesel 6 cylindres, modèle OM 906 LA (Euromot III A/EPA III), refroidi par eau. Réglage du nombre de tours par pédale, de 138 kW (188 CV) à 1800 min⁻¹. Couple: 750 Nm (76 kpm) à 1200 - 1600 min⁻¹. Puissance selon DIN 6270B/DIN 6271. Dépôt de combustible 250 l.

Système hydraulique Diesel-hydraulique à 3 circuits, 1 double pompe à pistons axiaux, 1 pompe à pistons axiaux et 1 pompe à engreages.

Commande 2 manipulateurs à commande en croix (4 sens), assistés électriquement.

Flèche télescopique 1 flèche de base et 6 éléments télescopiques en acier fin, 1 vérin télescopique, hydrauliquement télescopable avec charge partielle. Longueur de 13,2 m à 68,0 m.

Mécanisme de relevage 1 vérin différentiel muni de clapet de freinage de descente.

Mécanisme de levage Moteur à pistons axiaux, tambour de levage avec boîte planétaire incorporée, frein d'arrêt à disques multiples à ressort, libéré lors du levage. Câble de levage avec dispositif 'Super-Stop'.

Orientation Moteur à pistons axiaux, boîte à engrenages planétaires à 3 gammes avec frein de stationnement automatique, circuit fermé avec déconnexion de l'orientation. Vitesse de rotation 0 à 1,2 min⁻¹ en continu.

Contrepoids Poids total 71 t divisible, commandé depuis la cabine du grutier.

Cabine du grutier Cabine de grue spacieuse, construction en matière combinée acier/synthétique, avec vitrage de sécurité en verre teinté, siège réglable et amorti hydrauliquement, inclinable avec instruments de commande, chauffage à eau chaude dépendant et indépendant du moteur (avec préchauffage du moteur), éléments de commande et de contrôle avec affichage digital pour travaux.

Système électrique 24 V courant continu, 2 batteries.

Dispositifs de sécurité 'Lift Adjuster', limiteur de charge (CEC), anémomètre, limitation de zone de travail, interrupteur de fin de course de levage et de treuil, indicateur du nombre de tours, soupapes de sécurité contre ruptures des conduites et flexibles, clapets sur verins hydraulique.

Équipement supplémentaire (avec supplément de prix) Fléchette de 13,2 m à 37,2 m, fléchette pour levage lourde 5,4 m, combinaison différentes de contrepoids 12 t / 23,5 t / 35 t / 47 t, moufles de 10 t à 160 t, climatisation, 2^{ème} treuil de levage (identique au treuil principale), peinture spéciale et inscription.

Autres équipements supplémentaires sur demande.

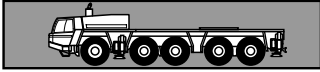

Chasis portante Construcción de acero de alta resistencia soldado, resistente a la torsión y a la flexión. Sistema de engrase central.

Estabilizadores Estabilizadores hidráulicos de 4 puntos. Posibilidad de manejo desde ambos lados del chasis portante y desde la cabina de la grúa. Extensión de los estabilizadores: 8,3 m (y 5,6 m) x 9,01 m.

Motor Mercedes Benz modelo OM 502 LA (Euromot III A/EPA III), 8 cilindros, diesel, refrigerado por agua. Nominal 390 kW (530 HP) a 1800 min⁻¹. Par 2400 Nm (245 kpm) a 1300 min⁻¹. Potencia del motor según 80/1269/EWG. Réservoir à carburant 530 l.

Transmisión Transmisión mecánica tipo ZF-AS Tronic modelo 16 AS 2602 con accionamiento electro - neumáticamente embrague en seco y cambio automático 16 marchas delanteras y 2 marchas traseras.

Transmisión Caja de distribución de dos escalones.

Tracción 10 x 8 (10 x 6 como opción*)

Ejes

- 1º eje: de dirección, accionado (*no accionado), con bloqueo diferencial transversal.
- 2º eje: de dirección, accionado, conectar según necesidad, con bloqueo diferencial transversal.
- 3º eje: no accionado, no direccionable, elevable.
- 4º eje: de dirección, accionado, con bloqueo diferencial longitudinal y transversal.
- 5º eje: de dirección, accionado, con bloqueo diferencial transversal.

Suspensión Suspensión hidroneumática con regulación de nivel.

Sistemas de frenos Accionamiento neumático de doble circuito. Freno de estacionamiento del tipo muelles cargados, liberados por aire, sobre los ejes 2º, 4º y 5º. Intarder y freno continuo: sistema estrangulador constante y freno tipo estrangulación sobre el escape del motor diesel.

Neumáticos 10 x 14.00 R 25 (385/95 R 25).

Dirección Hidráulica ZF Servocom de doble circuito con bomba auxiliar de dirección. Dirección mecánica del 1º y 2º eje y direccionable del 4º eje hasta una velocidad de 25 km/h y del 5º eje hasta una velocidad de conducción de 50 km/h.

Cabina Cabina para dos personas, en construcción de acero y fibra de vidrio. Cristales de seguridad, asiento con suspensión neumática, calefacción por agua caliente del motor. Elementos de control e instrumentos para circulación por carretera. Regulador de velocidad, sistema automático de frenado.

Sistema eléctrico Sistema de 24 V c.c. con 2 baterías, conexiones eléctricas integradas en el sistema CAN-Bus, sistema integrado de diagnóstico Faun-CSS. Faros en gatos. El sistema eléctrico cumple la normativa CEE.

Equipo adicional (con suplemento de precio) Embrague de remolque, calefacción adicional con precalefacción del motor, climatización, ABS, neumáticos 16.000 R 25 (445/95 R 25), 20.5 R 25 (525/80 R 25) rueda de repuesto, pintura especial e inscripción. Control carga (gatos de apoyo).

Otros equipamientos sobre demanda.

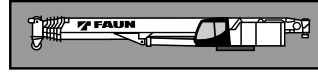

Superestructura Construida en aceros soldados, resistente a la torsión. Corona de giro con rodamiento de una fila de bolas con dientes externos para giro continuo a 360°. Sistema de engrase central.

Motor Mercedes Benz modelo OM 906 LA (Euromot III A/EPA III), 6 cilindros, diesel, refrigerado por agua. Las revoluciones aumentan de forma gradual accionado el acelerador. Nominal 138 kW (188 HP) a 1800 min⁻¹. Par 750 Nm (76 kpm) a 1200 - 1600 min⁻¹. Potencia del motor según DIN 6270B/DIN 6271. Réservoir à carburant 250 l.

Sistema hidráulico Sistema hidráulico de 3 circuitos, 1 bomba doble de pistones axiales, una bomba de pistones axiales y una bomba de ruedas dentadas.

Mandos 2 palancas de control de tipo joy-stick para movimientos simultáneos de la grúa (4 direcciones), asistidos eléctricamente.

Pluma telescópica 7 secciones, un tramo base y 6 telescópicos de acero de alta resistencia soldado, 1 cilindro hidráulico, los tramos se pueden telescopar hidráulicamente bajo carga. Longitud de 13,2 m a 68,0 m.

Elevación de pluma Mediante un cilindro hidráulico de doble efecto con válvula de retención integrada.

Cabrestante principal Motor hidráulico de pistones axiales y caudal fijo. Tambor del cabrestante con reducción planetaria y frenos de disco múltiples accionado, con sistema libre de elevación. Cable de elevación con sistema de enhebrado fácil y 'Super-Stop'.

Sistema de giro Motor hidráulico de pistones axiales con reducción planetaria de tres etapas. Con freno de giro automático. Circuito cerrado con mecanismo de giro libre con posibilidad de desconexión. Velocidad de giro gradual de 0 a 1,2 min⁻¹.

Contrapeso Peso total 71 t divisible, accionado desde la cabina de la grúa.

Cabina de la grúa Cabina espaciosa y confortable, en construcción de acero y fibra de vidrio, con cristales coloreados de seguridad. Asiento del operador regulable amortiguado hidráulicamente, inclinable junto con los instrumentos y mandos, calefacción por agua caliente dependiente e independiente del motor (con precalefacción del motor). Controles, instrumentos y mandos de conducción como display digital LCD para la operación de la grúa.











Sistema eléctrico Sistema de 24 V c.c. con 2 baterías.

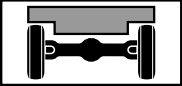



Medidas de seguridad 'Lift Adjuster', limitación del momento de carga (LMC), anemómetro, limitación del área de trabajo, interruptor de final de elevación, interruptor de 3 últimas vueltas en cabrestante, indicador de bajada o subida del cable del cabrestante, válvulas de seguridad para rotura de tubos y latiguillos. Válvulas de retención en los cilindros hidráulicos.

Equipo adicional (con suplemento de precio) Plumín de 13,2 m a 37,2 m, punta pesada 5,4 m, Variantes de contrapeso 12 t / 23,5 t / 35 t / 47 t, climatización, Gancho de 10 a 160 to. 2º cabrestante (similar a cabrestante principal), pintura especial y rotulación.

Otros equipamientos sobre demanda.

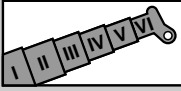
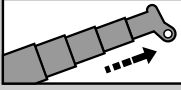
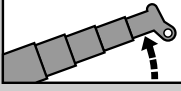
Symbolerklärung Symbols Glossaire des symboles Glosario de simbolos

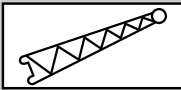
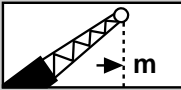
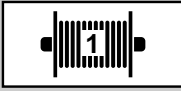
	Siehe Seite 40 As on Page 40 Voyez la page 40 Véase la pagina 40
	Abstützung Outriggers Calage Estabilizadores
	Getriebe / Gang Transmission / Gear Boîte de vitesse / Rapport Transmisión / Marchas
	Achslast Axle load Charge à l'essieu Carga por eje
	Räder / Größe Tyres / Size Pneus / Largeur Neumáticos / Tamaño de ruedas
	14.00 (385/95)
	Gelände Off road Tout-terrain Todo terreno
	Straße On road En route En carretera
	Geschwindigkeiten Speeds Vitesses Velocidades
	Steigfähigkeit Gradeability Abtitude en pente Superacion de pendientes
	Drehwerk Slewing system Orientation Sistema de giro
	Gegengewicht Counterweight Contrepoids Contrapeso

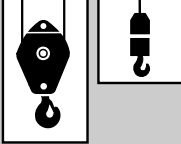
	Teleskopausleger Telescopic boom Flèche télescopique Pluma telescópica
	Teleskopieren Boom telescoping Télescopage de flèche Telescopaje de pluma
	Wippwerk Derricking system Mécanisme de relevage Elevación de pluma
	Ausladung Radius Portée Radio
	Auslegerverlängerung Boom extension Fléchette Plumín
	Ausladung Radius Portée Radio
	Hubwerk Main winch Mécanisme de levage Cabrestante principal
	2. Hubwerk Auxiliary winch 2 ^{ème} treuil de levage 2 ^º cabrestante
	Unterflasche / Hakengeschirr Hook block / Swivel hook Moufle / Elingues Gancho / Gancho de bola